

Video Service Manual

GDV 120
GDV 120/02
GMI5500



Zusätzlich erforderliche Unterlagen für den Komplettservice
Additionally required Service Documents for the Complete Service

**Service
Manual**

**Sicherheit
Safety**

Materialnr./Part No.
72010 800 0000

Grundig Service

Hotline Deutschland...
...Mo.-Fr. 8.00-18.00 Uhr

Technik:

TV	0180/52318-41
TV	0180/52318-49
SAT	0180/52318-48
VCR/LiveCam	0180/52318-42
HiFi/Audio	0180/52318-43
Car Audio	0180/52318-44
Telekommunikation	0180/52318-45
Fax:	0180/52318-51
Planatron (8.00-22.00 Uhr)	0180/52318-99

Ersatzteil-Verkauf:

Mo.-Fr. 8.00-19.00 Uhr

Telefon:	0180/52318-40
Fax:	0180/52318-50

Materialnummer/Part Number 72010 539 3500

Änderungen vorbehalten/Subject to alteration • Printed in Germany

E-BS35 0700

<http://www.grundig.com>

Es gelten die Vorschriften und Sicherheitshinweise gemäß dem Service Manual "Sicherheit", Materialnummer 72010 800 0000, sowie zusätzlich die eventuell abweichenden, landesspezifischen Vorschriften!



The regulations and safety instructions shall be valid as provided by the "Safety" Service Manual, part number 72010 800 0000, as well as the respective national deviations.

D

Inhaltsverzeichnis

	Seite
Allgemeiner Teil	1-2...1-16
Messgeräte / Messmittel	1-2
Technische Daten	1-3
Ausbauhinweise	1-3
Servicehinweise	1-6
LASER-Sicherheit	1-6
Bedienhinweise	1-7

Fehlersuchdiagramm und Blockschaltpläne

Fehlersuchdiagramm	2-1
Reset	2-2
Takt	2-2
DVD/VCD- und CD-Signalverarbeitung	2-3
Laufwerksteuerung	2-4

Platinenabbildungen und Schaltpläne

Verdrahtungspläne	3-1
Netzteil	3-2
Bedieneinheit	3-5
Kopfhörerplatte	3-7
Buchsenplatten	3-9
MPEG-Platte – GDV 120	3-12
Laufwerkplatte – GDV 120	3-21
MPEG-Platte – GDV 120/02	3-29
Laufwerkplatte – GDV 120/02	3-39
Oszillogramme	3-47
DC-Spannungen	3-50

Explosionszeichnungen und Ersatzteillisten

„Dolby“, „Dolby Pro Logic“, „AC 3“ ist gefertigt unter Lizenz von Dolby Laboratories Licensing Corporation.
„Dolby“, „Dolby Pro Logic“, „AC 3“ und das Doppel-D-Symbol „DD“ sind Warenzeichen der Dolby Laboratories Licensing Corporation. Copyright 1992 Dolby Laboratories, Inc. Alle Rechte vorbehalten.

GB

Table of Contents

	Page
General Section	1-2...1-26
Test Equipment / Jigs	1-2
Specifications	1-3
Disassembly Instructions	1-3
Service Instructions	1-6
LASER Safety	1-6
Operating Hints	1-17

Trouble Shooting Diagram and Block Circuit Diagrams

Trouble Shooting Diagram	2-1
Reset	2-2
Clock	2-2
DVD/VCD and CD Signal Path	2-3
Drive Control	2-4

Layout of PCBs and Circuit Diagrams

Wiring Diagrams	3-1
Power Supply	3-2
Control Board	3-5
Headphone Board	3-7
Socket Boards	3-9
MPEG Board – GDV 120	3-12
Drive Board – GDV 120	3-21
MPEG Board – GDV 120/02	3-29
Drive Board – GDV 120/02	3-39
Oscillograms	3-47
DC Voltages	3-50

Exploded Views and Spare Parts Lists

„Dolby“, „Dolby Pro Logic“, „AC 3“ manufactured under license from Dolby Laboratories Licensing Corporation.
„Dolby“, „Dolby Pro Logic“, „AC 3“ and the double-D symbol „DD“ are trademarks of the Dolby Laboratories Licensing Corporation. Copyright 1992 Dolby Laboratories, Inc. All rights reserved.

Allgemeiner Teil

Messgeräte / Messmittel

Regeltrenntrafo	Zweikanaloszilloskop
Digitalmultimeter	Millivoltmeter
Frequenzzähler	

Beachten Sie bitte das Grundig Messtechnik-Programm, das Sie unter folgender Adresse erhalten:

General Section

Test Equipment / Jigs

Variable isolating transformer	Dual channel oscilloscope
Digital multimeter	Millivoltmeter
Frequency counter	

Please note the Grundig Catalog "Test and Measuring Equipment" obtainable from:

Grundig AG
Geschäftsbereich Instruments
Test- und Messsysteme
Würzburger Str. 150, D-90766 Fürth
Tel.: 0911 / 703-4118; Fax: 0911 / 703-4130
eMail: instruments@grundig.de
Internet: http://www.grundig-instruments.de

Technische Daten

Netzspannung:	220V...240V~, 50/60Hz
Gewicht:	ca. 4kg
Leistungsaufnahme:	ca. 16W
Stand by:	≤2W
Maße (B x H x T):	435 x 87 x 275mm
Umgebungstemperatur:	+10°C ... +35°C
Wiedergabe-Norm:	PAL, 50Hz, 625 Zeilen NTSC, 60Hz, 525 Zeilen
Wiedergabe-System:	DVD-Video, Video-CD, Audio-CD
DVD Disk Format:	Durchmesser 8cm und 12cm
Laser:	Halbleiter-Laser, Wellenlänge 650nm
Audio Format	
Digital:	MPEG/AC-3 Compressed Digital, PCM, DTS
Analog:	Stereoton und Dolby Pro Logic

Audio Performance

Signal:	Analog	
DVD:	fs 96kHz	17Hz ... 20kHz
	fs 48kHz	17Hz ... 20kHz
VCD:	fs 48kHz	17Hz ... 20kHz
CD:	fs 44,1kHz	20Hz ... 20kHz
Rauschabstand (1kHz):	>100dB	
Dynamik (1kHz):	>95dB	

Ausbauhinweise

Öffnen der Schublade bei defektem Laufwerk

- Laufwerkeinheit ausbauen (Pkt. 8).
- Zahnrad **A** (Fig. 9) so lange in Pfeilrichtung drehen bis sich die Schublade bewegt.
- Die Schublade kann jetzt herausgezogen werden.

1. Gehäuseoberteil

- 6 Schrauben **A** herausdrehen (Fig. 1).

2. Frontblende

- Drehknopf des Kopfhörer-Lautstärkereglers abziehen.
- 3 Schrauben **B** herausdrehen (Fig. 2).
- Rasthaken **C** (Fig. 3) auf beiden Seiten lösen und Frontblende abnehmen.
- Gegebenenfalls Steckverbindungen und Masseverbindung lösen.

3. Bedieneinheit ausbauen

- 8 Schrauben **D** (Fig. 4) herausdrehen.
- Bedieneinheit abnehmen.



Fig. 1

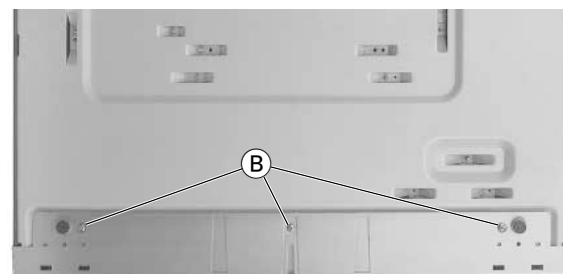

Fig. 2

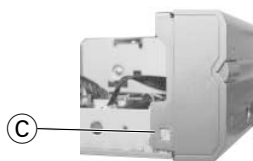

Fig. 3

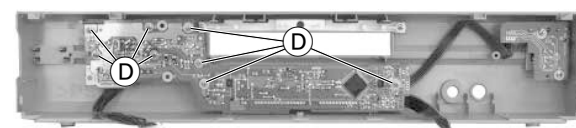

Fig. 4

Specifications

Supply Voltage:	220V...240V~, 50/60Hz
Weight:	ca. 4kg
Power Requirement:	ca. 16W
Stand by:	≤2W
Dimensions (W x H x D):	435 x 87 x 275mm
Ambient Temperature:	+10°C ... +35°C
Playback Norm:	PAL, 50Hz, 625 lines NTSC, 60Hz, 525 lines
Playback System:	DVD-Video, Video-CD, Audio-CD
DVD Disc Format:	Diameter 8cm and 12cm
Laser:	Semiconductor laser, Wavelength 650nm
Audio Format	
Digital:	MPEG/AC-3 Compressed Digital, PCM, DTS
Analog:	Stereo sound and Dolby Pro Logic

Audio Performance

Signal:	Analog	
DVD:	fs 96kHz	17Hz ... 20kHz
	fs 48kHz	17Hz ... 20kHz
VCD:	fs 48kHz	17Hz ... 20kHz
CD:	fs 44,1kHz	20Hz ... 20kHz
Signal-to-noise ratio (1kHz):	>100dB	
Dynamic range (1kHz):	>95dB	

Disassembly Instructions

Opening the Tray when the Drive is defective

- Remove the Drive Mechanism (para 8).
- Turn the toothed wheel **A** (Fig. 9) in direction of the arrow until the tray moves.
- Now the tray can be pulled out.

1. Cabinet Upper Part

- Undo 6 screws **A** (Fig. 1).

2. Front Panel

- Pull off the headphone volume control knob.
- Undo 3 screws **B** (Fig. 2).
- Release the catches **C** (Fig. 3) on both sides and remove the front panel.
- Unplug the connectors and chassis connections if necessary.

3. Removing the Keyboard Control Unit

- Undo 8 screws **D** (Fig. 4).
- Remove the Keyboard Control Unit.

4. Kopfhörerplatte ausbauen

- 2 Schrauben (E) (Fig. 5) herausdrehen und Kopfhörerplatte abnehmen.
- Gegebenenfalls Steckverbindungen lösen.

5. MPEG-Platte ausbauen

- 3 Schrauben (F) (Fig. 5) herausdrehen und MPEG-Platte aus dem Gerät nehmen.
- Gegebenenfalls Steckverbindungen lösen.

6. Buchsenplatten ausbauen

- 7 Schrauben (G) (Fig. 6) herausdrehen und Abdeckung (H) abnehmen.
- 4 Schrauben (I) (Fig. 5) herausdrehen und Buchsenplatte aus dem Gerät nehmen.
- Schraube (J) (Fig. 5) herausdrehen und AV-Platte aus dem Gerät nehmen.
- Gegebenenfalls Steckverbindungen lösen.

7. Netzteil ausbauen

- 5 Schrauben (K) (Fig. 5) herausdrehen und Netzteil aus dem Gerät nehmen.
- Gegebenenfalls Steckverbindungen lösen und Netzkabel ablöten.

8. Laufwerkeinheit ausbauen

- 4 Schrauben (L) (Fig. 5) herausdrehen.
- Laufwerkeinheit in Richtung Geräterückseite aus dem Gerät nehmen.
- Gegebenenfalls Steckverbindungen lösen.

9. Laufwerk zerlegen

- Laufwerk ausbauen (Pkt. 8).

9.1 Laufwerkplatte ausbauen

- GDV 120: 2 Schrauben (M) (Fig. 8) herausdrehen und Laufwerkplatte abnehmen.
- GDV 120/02: 4 Schrauben (M) (Fig. 7) herausdrehen und Laufwerkplatte abnehmen.

- Gegebenenfalls Steckverbindungen lösen.

Achtung: Die Lasereinheit ist sehr empfindlich gegen statische Aufladungen (MOS-Bauteile)!

Schließen Sie deshalb die Flexprintleitung zur Lasereinheit **vor dem Abziehen** mit einer Büroklammer kurz.

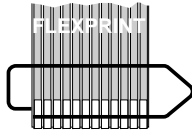
**9.2 Laufwerkhalter ausbauen**

- Schraube (B) (Fig. 9) herausdrehen.
- 4 Schrauben (C) (Fig. 9) herausdrehen und Laufwerkhalter abnehmen.

9.3 Schublade ausbauen

- 2 Schrauben (D) (Fig. 10) herausdrehen.
- Rastnasen (E) (Fig. 10) lösen und Laufwerkoberseite abnehmen.
- Schublade abnehmen.

Montagehinweis:

- Zahnrad (F) (Fig. 11) bis Anschlag im Uhrzeigersinn drehen.
- Zahnrad (F) (Fig. 11) entgegen dem Uhrzeigersinn drehen bis das Loch (G) des Zahnrades dem Loch des Chassis gegenüber steht. Des Weiteren muss zwischen den beiden Markierungen (H) des Zahnrades der schmale Steg (I) des Zahnrades gegenüber stehen.
- Schublade so aufsetzen, dass der mittlere Zahn (J) (Fig. 12) der Schublade in die markierte Lücke (K) des Zahnrades greift.
- Schublade durch Montage des Laufwerkoberteils fixieren.

9.4 Lasereinheit ausbauen

- GDV 120: 2 Schrauben (L) (Fig. 14) herausdrehen und Laufwerk herausnehmen.
- GDV 120/02: 4 Schrauben (L) (Fig. 13) herausdrehen und Laufwerk herausnehmen.

9.5 Lademotor ausbauen

- Riemen (P) (Fig. 11) abnehmen.
- 2 Schrauben (R) (Fig. 11) herausdrehen und Lademotor herausnehmen.

9.6 Sledge-Motor ausbauen

- GDV120:
 - Sicherungsscheiben (S) (Fig. 14) abnehmen.
 - Zahnräder (T) (Fig. 14) herausnehmen.
 - 2 Schrauben (U) (Fig. 15) herausdrehen und Sledge-Motor nach unten herausnehmen.
- GDV120/02: 2 Schrauben (U) (Fig. 13) herausdrehen und Sledge-Motor nach unten herausnehmen.

4. Removing the Headphone Board

- Undo 2 screws (E) (Fig. 5) and remove the Headphone Board.
- Unplug the connectors if necessary.

5. Removing the MPEG Board

- Undo 3 screws (F) (Fig. 5) and remove the MPEG Board.
- Unplug the connectors if necessary.

6. Removing the Socket Boards

- Undo 7 screws (G) (Fig. 6) and remove the cover (H).
- Undo 4 screws (I) (Fig. 5) and remove the Socket Board.
- Undo screw (J) (Fig. 5) and remove the AV Board.
- Unplug the connectors if necessary.

7. Removing the Power Supply

- Undo 5 screws (K) (Fig. 5) and remove the Power Supply.
- Unplug the connectors and unsolder the power supply cable if necessary.

8. Removing the Drive Mechanism

- Undo 4 screws (L) (Fig. 5).
- Remove the CD drive to the rear of the cabinet.
- Unplug the connectors if necessary.

9. Disassembling the Drive Mechanism

- Remove the drive mechanism (para 8).

9.1 Removing the Drive Board

- GDV 120: Undo 2 screws (M) (Fig. 8) and remove the Drive Board.
- GDV 120/02: Undo 4 screws (M) (Fig. 7) and remove the Drive Board.
- Unplug the connectors if necessary.

Attention: The laser unit is very sensitive to static charges (MOS components)! Therefore, short-circuit the Flexprint to the laser unit with a paper clip **before disconnecting** it.

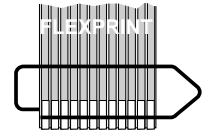
**9.2 Removing the Drive Mechanism Holder**

- Undo the screw (B) (Fig. 9).
- Undo the 4 screws (C) (Fig. 9) and remove the drive mechanism holder.

9.3 Removing the Tray

- Undo 2 screws (D) (Fig. 10).
- Release the locking lugs (E) (Fig. 10) and remove the top part of the drive mechanism.
- Remove the tray.

Reassembly hint:

- Turn the toothed wheel (F) (Fig. 11) clockwise until its end stop.
- Turn the toothed wheel (F) (Fig. 11) counter clockwise until the hole (G) in the toothed wheel faces the hole in the chassis. In addition the narrow ridge (I) of the toothed wheel must face the two marks (H) on the toothed wheel.
- Fit the tray so that the centre tooth (J) (Fig. 12) of the tray engages into the marked gap (K) of the toothed wheel.
- Fix the tray by fitting the top part of the drive mechanism.

9.4 Removing the Laser Unit

- GDV 120: Undo 2 screws (L) (Fig. 14) and remove the drive mechanism.
- GDV 120/02: Undo 4 screws (L) (Fig. 13) and remove the drive mechanism.

9.5 Removing the Loading Motor

- Remove the belt (P) (Fig. 11).
- Undo 2 screws (R) (Fig. 11) and remove the loading motor.

9.6 Removing the Sledge Motor

- GDV120:
 - Remove the lock washers (S) (Fig. 14).
 - Remove the toothed wheels (T) (Fig. 14).
 - Undo 2 screws (U) (Fig. 15) and remove the Sledge motor in downward direction.
- GDV 120/02: Undo 2 screws (U) (Fig. 13) and remove the Sledge motor in downward direction.

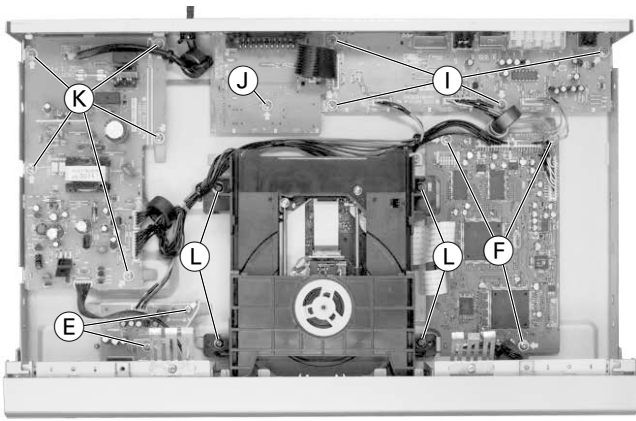

Fig. 5

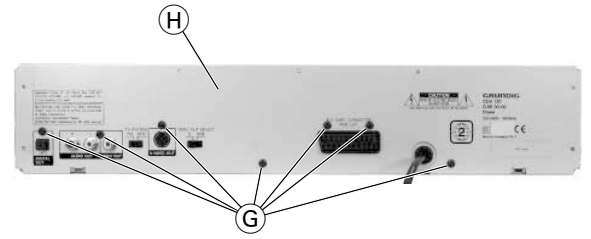

Fig. 6

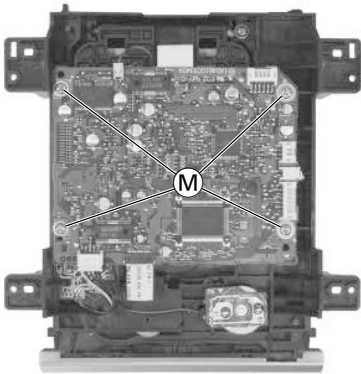

Fig. 7



Fig. 8



Fig. 9

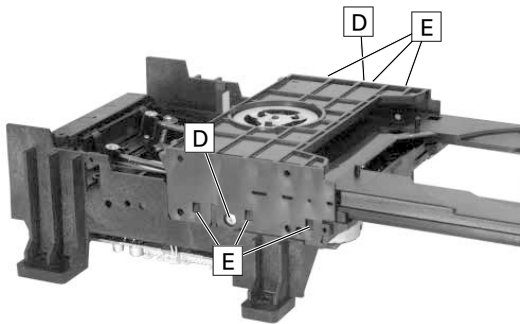

Fig. 10

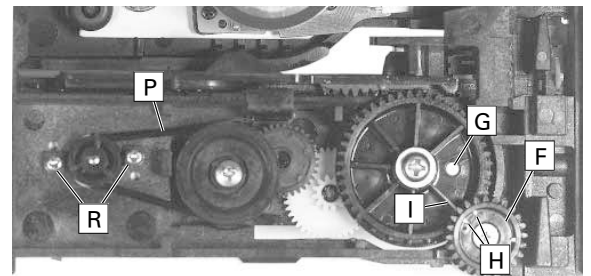

Fig. 11

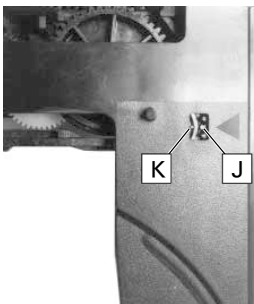

Fig. 12

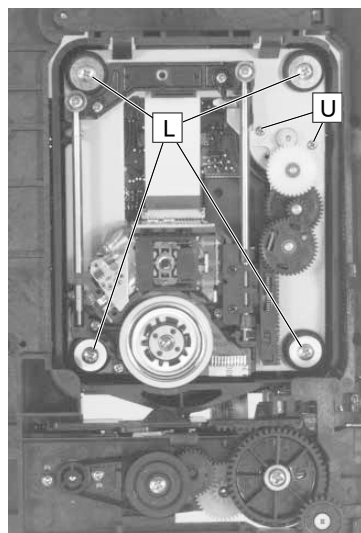

Fig. 13

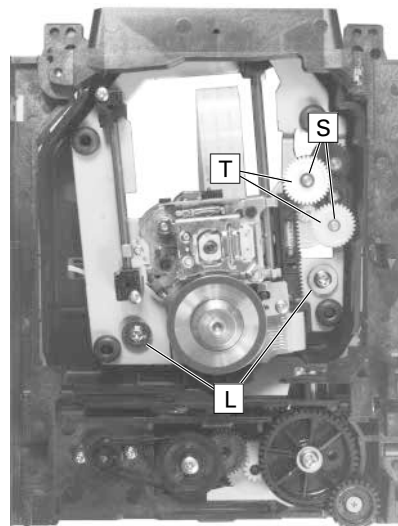

Fig. 14

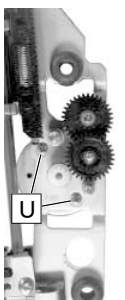

Fig. 15

Servicehinweise

Wichtige Masseverbindungen!

Beim Zusammenbau des Gerätes ist darauf zu achten, dass die Masseverbindungen zwischen den einzelnen Platinen und dem Rahmen sowie dem Laufwerk und dem Rahmen gewährleistet sind.

Durchführen von Messungen

Bei Messungen mit dem Oszilloskop an Halbleitern sollten Sie nur Tastköpfe mit 10:1 - Teiler verwenden. Außerdem ist zu beachten, dass nach vorheriger Messung mit AC-Kopplung der Koppelkondensator des Oszilloskops aufgeladen sein kann. Durch die Entladung über das Messobjekt können diese Bauteile beschädigt werden.

Messwerte und Oszillogramme

Bei den in den Schaltplänen und Oszillogrammen angegebenen Messwerten handelt es sich um Näherungswerte

LASER-Sicherheit

Da viele Bauteile, besonders die Laserdiode, gegen statische Aufladungen empfindlich sind, müssen die MOS- Vorschriften eingehalten werden.

Die Abtasteinheit besteht aus vielen Präzisionsteilen und sollte vor hohen Temperaturen, hoher Luftfeuchtigkeit, starken Magnetfeldern, starken Erschütterungen und Staub geschützt werden.

- DVD- und CD-Spieler gehören zur Gerätegruppe mit LASERN geringer Leistung.
- Nach DIN VDE 0837 bzw. IEC 825 handelt es sich um einen LASER der Klasse 1. Das besagt, die Ausgangsleistung ist konstruktiv begrenzt. Ein Betrieb der LASER-DIODE außerhalb der Abtasteinheit ist beim Betrachten des LASER-Lichtes für das Auge schädlich, da die Ausgangsleistung um ein Vielfaches höher liegt (Klasse 3 B). In diesem Fall ist das Tragen einer Laserschutzbrille zwingend vorgeschrieben.
- Durch das Linsensystem der Abtasteinheit liegt der Brennpunkt des LASER-Lichtes etwa 1,5mm über der Fokulinse.
- Das Betrachten des LASERS mit externen Optiken, z.B. Lupe, ist zu unterlassen, da diese den Brennpunkt auf die Netzhaut des Auges projizieren und so das Auge geschädigt werden kann.
- Das LASER-Licht kann an der Fokulinse des Abtasters als ein dunkelroter Punkt beobachtet werden, wenn man schräg auf die Optik sieht. Die Umgebungshelligkeit soll dabei nicht zu groß sein.
- Durch das Auflegen eines Transparentpapiers auf die Fokulinse ist der LASER-Punkt als Projektion auf die Papierrückseite gut erkennbar.

Sicherheitsverriegelungen verhindern im Normalfall, dass der LASER bei geöffnetem Deckel arbeitet. Unter Beachtung o.g. Hinweise lassen sich die schaltungsspezifischen Sicherheitsverriegelungen ausschalten und der LASER wird als kleiner roter Punkt sichtbar.

Sicherheitsklassen der LASER (nach DIN IEC 825 / VDE 0837)

Klasse 1

Ungefährlich für das menschliche Auge. Maximale Ausgangsleistung z.B. bei 700nm...69µW.

Klasse 3 B

Service Instructions

Important: Chassis Connections!

When reassembling the machine it is essential to observe that the chassis connections between the individual circuit boards and the frame as well as between the Drive Mechanism and the frame are in good order.

Carrying out Measurements

When making measurements on semi-conductors with an oscilloscope, ensure that the test probe is set to 10:1 dividing factor. Further, please note that if the previous measurement is made on AC input, the coupling capacitor in the oscilloscope will be charged. Discharge via the item being checked can damage components.

Measured Values and Oscillograms

The measured values given in the circuit diagrams and oscillograms are approximates!

LASER Safety

The MOS safety requirements must be met because many components, particularly the laser diode, are very sensitive to static electricity. The pick-up unit incorporates many precision components and should therefore be protected against high temperatures, high humidity, strong magnetic fields, mechanical shocks and dust.

- The DVD/CD Player belongs to the category of products with a low-power LASER.
- According to DIN VDE 0837 or IEC 825 it is a Class 1 LASER meaning that the output power limits are determined by the design. The LASER DIODE must not be operated outside the pick-up since the output power increases by many times (Class 3B) and will cause injuries to the eye. In this case the use of LASER protective goggles is strictly recommended.
- Due to the lens system of the LASER pick-up the focal point of the LASER light is about 1.5mm above the focus lens.
- Do not look at the LASER using external optical means such as, for example, a magnifying glass because the focal point will be projected onto the retina and may cause injuries to the eye.
- The LASER light appears on the focus lens of the pick-up as a dark-red spot when looking at the optical system at an angle, preferably at low ambient brightness.
- By placing a sheet of transparent paper onto the focus lens the LASER spot is projected onto the back of the sheet and is well perceivable.

In general, built-in safety locks ensure that the LASER does not operate with an open disc compartment cover. In consideration of the above instructions, the special safety locks can be made ineffective and the LASER will be visible as a small red spot.

Safety Standard Classes for the LASER (according to DIN IEC 825 / VDE 0837)

Class 1

Not dangerous for the human eye. Maximum output power eg: at 700nm...69µW.

Class 3 B



Gefährlich für das menschliche Auge und in besonderen Fällen für die Haut. Maximale Strahlungsleistung bis 0,5W.



Dangerous for the human eye and, in special cases, for the skin. Maximum radiation power up to 0.5W.

Das austretende Laserlicht des CD-Lichtpens entspricht der Klasse 1. Wird die Laserdiode außerhalb des Lichtpens betrieben, entspricht dieses dem Betrieb der Klasse 3 B.

The output of laser light from a CD pick-up unit corresponds to Class 1. If the laser diode is operated outside pick-up unit, this corresponds to operation under Class 3 B.

Bedienhinweise Dieses Kapitel enthält Auszüge aus der Bedienungsanleitung. Weitergehende Informationen entnehmen Sie bitte der gerätespezifischen Bedienungsanleitung, deren Materialnummer Sie in der Ersatzteilliste finden.

AUF EINEN BLICK

Die Vorderseite des DVD-Players

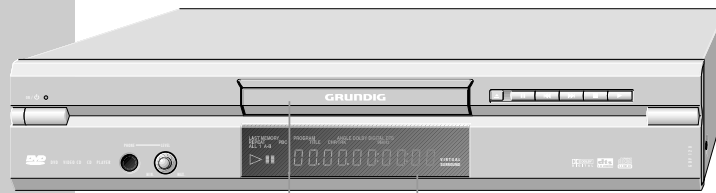

- Schaltet den DVD-Player aus Stand-by ein und wieder aus (Stand-by).
Der DVD-Player wird beim Ausschalten nicht vollständig vom Stromnetz getrennt.
- Stand-by Anzeige.
- PHONE** Kopfhörerbuchse, zum Anschließen eines Stereo-Kopfhörers mit Klinkenstecker (ø 6,3 mm).
- LEVEL** Lautstärkeeinsteller, für einen Kopfhörer an Buchse »PHONE«.
- A Schublade für DVD/CD.
- B Anzeige.
- Leuchtanzeige für Virtual Surround-Funktion.
- Zum Öffnen und Schließen der Schublade.
- Standbild bei DVDs und Video-CDs; Pause bei Audio-CDs.
- Wählt den vorherigen Titel oder Abschnitt während der Wiedergabe.
- Wählt den nächsten Titel oder Abschnitt während der Wiedergabe.
- Unterbricht jede Lauffunktion, schaltet auf „STOPP“.
- Startet die Wiedergabe.

AUF EINEN BLICK

Die Anzeigen des DVD-Players

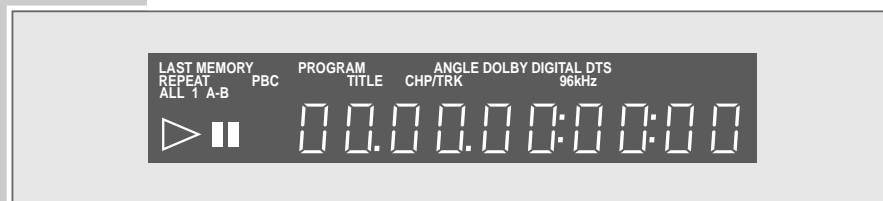

- »LAST MEMORY« Funktion ist aktiviert.
- »PBC« Video-CD in Verwendung.
- »PROGRAM« Funktion ist aktiviert.
- »01 TITLE« Nummer des Titels einer DVD.
- »01 CHP/TRK« Nummer des Abschnitts (CHP) einer DVD oder CD oder Nummer der Szene (TRK) einer DVD, Nummer des Musiktitels einer CD.
- »ANGLE« Funktion Blickwinkel ist aktiviert.
- »DOLBY DIGITAL« Die DVD bietet das Tonsignal mit Dolby Digital an.
- »DTS« Die DVD bietet das Tonsignal mit DTS an.
- »96 kHz« Audio Taktfrequenz 96 kHz.
- »00:00:00« Gesamtspielzeit oder abgelaufene Spielzeit in Stunden, Minuten und Sekunden.
- »REPEAT ALL 1 A-B« Eine der Repeat-Funktionen ist aktiviert.
- »||« Pause/Standbild.
- »▷« Wiedergabe.

AUF EINEN BLICK

Die Rückseite des DVD-Players

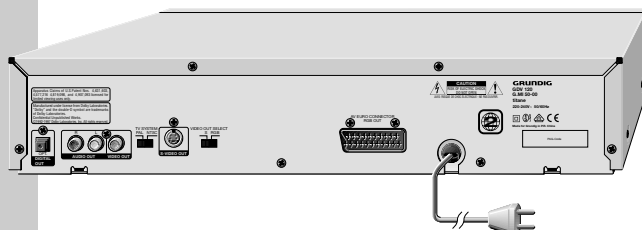

- OPT. DIGITAL OUT** Ton-Ausgangsbuchse (optisch) für PCM/MPEG2/AC3/ DTS Signale, zum Anschließen einer digitalen HiFi-Anlage.
- R AUDIO OUT L** Ton-Ausgangsbuchsen (rechter/linker Kanal) zum Anschließen einer HiFi-Anlage.
- VIDEO OUT** Bild-Ausgangsbuchse, zum Anschließen eines Fernsehgerätes mit Video-Buchse.
- TV SYSTEM PAL NTSC** Zum Einstellen des TV-Systems (PAL oder NTSC).
- S-VIDEO OUT** Bild-Ausgangsbuchse, zum Anschließen eines Fernsehgerätes mit S-VHS-Buchse.
- VIDEO OUT SELECT S RGB** Schaltet das Bild-Ausgangssignal auf Buchse »A/V EURO CONNECTOR« oder Buchse »S-VIDEO OUT«.
- A/V EURO CONNECTOR** Bild-/Ton-Ausgangsbuchse, zum Anschließen eines Fernsehgerätes.
-  Netzkabel.

Vorsicht:





Schließen Sie keine Geräte an, wenn der DVD-Player eingeschaltet ist.

Berühren Sie nicht die Innenseite der Buchsen und Stecker der Verbindungskabel. Eine elektrostatische Entladung kann den DVD-Player beschädigen.

AUF EINEN BLICK

Die Fernbedienung



-  **ON** Schaltet den DVD-Player aus Stand-by ein und wieder aus (Stand-by).
Die Anzeige am DVD-Player leuchtet rot bei Stand-by.
- PICTURE MODE** Zum Einstellen des Bildes bei der Wiedergabe.
- LAST MEMO** Markiert bei der Wiedergabe eine Stelle auf der DVD.
- VIRTUAL SURROUND** Aktiviert die Funktion Virtual Surround.
- OSD** Zum Ein- und Ausblenden der Menüs am Bildschirm des Fernsehgerätes.
- SUBTITLE** Blendet während der Wiedergabe die Untertitel der DVD ein.
- AUDIO** Schaltet während der Wiedergabe um zwischen Original- und Synchronsprache einer DVD.
- TITLE** Ruft während der Wiedergabe das Hauptmenü der DVD/Video-CD auf (abhängig von der DVD).
- MENU** Ruft während der Wiedergabe das Titelménü der DVD/Video-CD auf.
- ZOOM** Vergrößert Standbilder.
- SETUP** Ruft das Hauptmenü des DVD-Players auf (bei STOPP).
-    Wählen in den Menüs verschiedene Funktionen.
- OK** Bestätigt Eingaben in den Menüs.
- RETURN** Ruft das vorherige Menü der DVD auf.

AUF EINEN BLICK



- ◀◀ Schaltet während der Wiedergabe auf Bildsuchlauf rückwärts in verschiedene Geschwindigkeiten.
- ▶▶ Schaltet während der Wiedergabe auf Bildsuchlauf vorwärts in verschiedene Geschwindigkeiten.
- ◀ Zeitlupe rückwärts bei DVDs und Video-CDs.
- || Standbild bei DVDs und Video-CDs; Pause bei Audio-CDs.
- Beendet alle Funktionen, schaltet den DVD-Player auf „STOPP“.
- ▶ Zeitlupe bei DVDs.
- |◀▶| Wählen während der Wiedergabe den vorherigen Titel /Abschnitt oder den nächsten Titel/Abschnitt.
- ▶ Startet die Wiedergabe.
- C CLEAR** Löscht Titel oder Kapitel aus dem Programm.
- 1 ... 0** Ziffern-Tasten für verschiedene Eingaben.
- PROGRAM** Zum Programmieren von Titel oder Kapitel.
- SEARCH MODE** Zum Anwählen von Titel oder Kapitel.
- ANGLE** Wählt während der Wiedergabe verschiedene Blickwinkel (Kamera-Standorte) von bestimmten Szenen oder Passagen der DVD.
- ANGLE REPLAY** Wiederholt den gewählten Blickwinkel.
- BOOKMARK** Markiert Szenen der DVD.
- REPEAT** Wiederholt Abschnitte, Titel oder DVDs/CDs.
- A-B REPEAT** Wiederholt markierte Abschnitte.

ANSCHLIESSEN UND VORBEREITEN

Fernsehgerät anschließen...

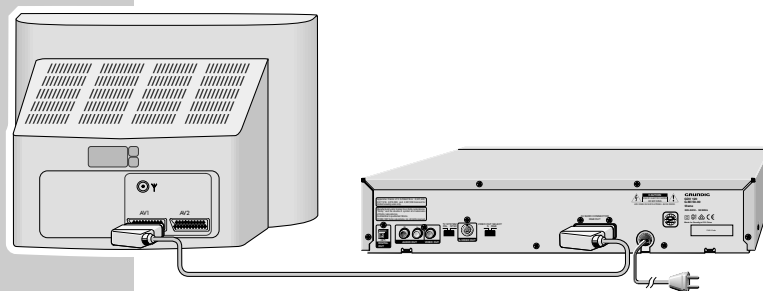

... mit einem EURO-AV-Kabel

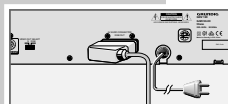

- 1 Beigepacktes EURO-AV-Kabel in die Buchse »**A/V EURO CONNECTOR**« des DVD-Players und in die entsprechende Buchse (AV 1) des Fernsehgerätes stecken, Schalter »**VIDEO OUT SELECT 5 RGB**« in Stellung »**RGB**« schieben;

oder

... mit Cinch-Kabel

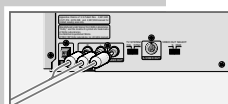

- 1 Handelsübliches Cinch-Kabel in die Buchse »**VIDEO OUT**« des DVD-Players und in die entsprechende Buchse (VIDEO IN) des Fernsehgerätes stecken.
- 2 Handelsübliches Cinch-AV-Kabel in die Buchsen »**R AUDIO L**« des DVD-Players und in die entsprechenden Buchsen (AUDIO IN) des Fernsehgerätes stecken,

oder

ANSCHLIESSEN UND VORBEREITEN



... mit Y/C-Kabel (S-VHS)

1 Handelsübliches Cinch-AV-Kabel in die Buchsen »R AUDIO L« des DVD-Players und in die entsprechenden Buchsen (AUDIO IN) des Fernsehgerätes stecken.

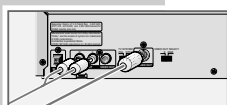

2 Handelsübliches Y/C-Kabel in die Buchse »S-VIDEO OUT« des DVD-Players und in die entsprechende Buchse (S-VIDEO IN) des Fernsehgerätes stecken, Schalter »VIDEO OUT SELECT S RGB« in Stellung »S« schieben.

Hinweise:

Wenn der DVD-Player an ein Fernsehgerät mit dem Format 16:9 angeschlossen wird, beachten Sie bitte die Einstellung im Kapitel „Format des Fernsehgerätes“ auf Seite 38.

Entsprechend der Ausstattung Ihres Fernsehgerätes muß die Farbnorm der Bildschirmmenüs des DVD-Players an das Fernsehgerät angepaßt werden. Schalter »TV SYSTEM« des DVD-Players in Stellung »PAL« (Fernsehgerät mit PAL-Norm) oder »NTSC« (Fernsehgerät mit NTSC-Norm) stellen.

HiFi-Anlage mit analogem Zweikanal-Stereoton anschließen

Alternativ zu den Lautsprechern des Fernsehgerätes kann der Ton auch über eine HiFi-Anlage wiedergegeben werden.

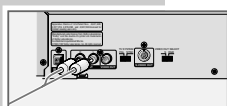

1 Handelsübliches Cinch-Kabel in die Buchsen »R AUDIO L« des DVD-Players und in die entsprechende Buchsen der HiFi-Anlage stecken.

Vorsicht:

Die Buchsen »R AUDIO L« des DVD-Players dürfen nicht an den PHONO-Eingangsbuchsen (Plattenspieler-Eingang) der HiFi-Anlage angeschlossen werden.

Hinweis:

Die Buchsen »R AUDIO L« sind auch für den Anschluß eines Pro Logic-Audio-/Video-Empfängers zu verwenden.

ANSCHLIESSEN UND VORBEREITEN

Digitalen Mehrkanal Audio-/Videoverstärker anschließen

Bei einem Mehrkanal Audio-/Videoempfänger (MPEG 2 Multi channel decoder oder Dolby* Digital Decoder) kann der digitale Mehrkanalton der DVD decodiert und optimal wiedergegeben werden.



1 Handelsübliches optisches Kabel in die Buchse »OPT. DIGITAL OUT« des DVD-Spielers und in die entsprechende Buchse des digitalen Mehrkanalverstärkers stecken.

* Gefertigt unter Lizenz von Dolby Laboratories Licensing Corporation. „Dolby“, „Dolby Pro Logic“, „AC 3“ und das Doppel-D-Symbol „DD“ sind Warenzeichen der Dolby Laboratories Licensing Corporation. Copyright 1992 Dolby Laboratories, Inc. Alle Rechte vorbehalten.

Hinweise:

Am DVD-Spieler muß der Digitalausgang aktiviert werden und das richtige digitale Ausgangsformat (MPEG oder PCM) eingestellt werden. Beachten Sie hierzu die Einstellungen im Kapitel „Einstellungen im Menü »Ton«“ ab Seite 39.

Bei der Wiedergabe einer DVD mit DTS-Tonsignal muß der Audio-/Video-Empfänger dieses DTS-Tonsignal verarbeiten können. Ist dies nicht der Fall, ist der Ton der DVD nicht zu hören.

Kopfhörer anschließen



1 Klinkenstecker des Kopfhörers in die Buchse »PHONE« des DVD-Spielers stecken.

Hinweis:

Die Lautstärke des Kopfhörers wird mit Regler »LEVEL« eingestellt.

WIEDERGABE EINER DVD/VIDEO-CD

Wiedergabe eines Titels



1 Nach dem Schließen der Schublade und dem „Einlesen“ der DVD startet die Wiedergabe automatisch.



2 Auf Wiedergabe-Pause (Standbild) mit »**II**« schalten.

3 Wiedergabe mit »▶« fortsetzen.

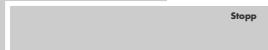

4 Wiedergabe mit »■« beenden.

Hinweise:

Abhängig von der verwendeten DVD/Video-CD kann es notwendig sein, aus einem Inhaltsverzeichnis der DVD/Video-CD Titel oder Kapitel auszuwählen.

Zum Auswählen benutzen Sie die Tasten »▲« oder »▼«, zum Aktivieren die Taste »OK«.

Ist die Auswahl numeriert, verwenden Sie die Tasten »1 ... 0«.

Wenn das Symbol »⊙« auf dem Bildschirm des Fernsehgerätes erscheint, ist die gewählte Funktion mit dieser DVD/Video-CD nicht möglich.

Funktionsanzeige aufrufen



Jede Funktion die Sie angewählt haben, kann am Bildschirm angezeigt werden (zum Beispiel die Spielzeit, der aktuelle Titel, usw.).

1 Funktionsanzeige mit »OSD« einblenden.

2 Funktionsanzeige mit »OSD« ausblenden.

WIEDERGABE EINER DVD/VIDEO-CD

Titel oder Kapitel anwählen ...

Wenn eine DVD/Video-CD mehrere Titel und/oder Kapitel enthält, können Sie diese anwählen.

... mit dem Menü des DVD-Players

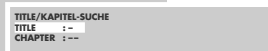

1 Menü mit »SEARCH MODE« einblenden.
– Die Zeile »TITLE« (für Titel) ist markiert.



2 Titel mit »1 ... 0« ein- oder zweistellig eingeben.

3 Zeile »CHAPTER« (für Kapitel) mit »▼« anwählen

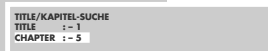

4 Kapitel mit »1 ... 0« ein- oder zweistellig eingeben.

Hinweis:

Wurde die falsche Nummer eingegeben, kann diese mit »CLEAR« gelöscht werden.

5 Eingabe mit »OK« bestätigen.

– Die Wiedergabe beginnt mit dem gewählten Titel oder dem gewählten Kapitel.

Hinweis:

Wenn das Symbol »⊙« erscheint, ist diese Funktion mit dieser DVD/Video-CD nicht möglich.

... mit dem Titelmü der DVD/Video-CD

Das Titelmü der DVD/Video-CD kann Auswahlmöglichkeiten für Titel, Abschnitte oder Szenen enthalten.

1 Inhalt der DVD/Video-CD mit »MENU« aufrufen.

– Wenn die DVD/Video-CD ein Titelmü enthält, erscheint es am Bildschirm.

WIEDERGABE EINER DVD/VIDEO-CD

- Wenn die Auswahlmöglichkeiten numeriert sind, entsprechenden Titel und Abschnitt mit »1 ... 0« wählen.
- Sind die Auswahlmöglichkeiten nicht numeriert, Titel und Abschnitte mit »▲«, »▼«, »◀« oder »▶« wählen und mit »OK« aktivieren.

Einen Abschnitt minutengenau anwählen

TITLE/KAPITEL-SUCHE
TITLE : --
CHAPTER : --

- Menü mit »SEARCH MODE« einblenden.
– Die Zeile »TITLE« (für Titel) ist markiert.

TIME SEARCH
TIME : -- h : -- m : -- s

- »SEARCH MODE« noch einmal drücken.
– Die Zeile »TIME SEARCH« (Suche nach Zeit) erscheint.

TIME SEARCH
TIME : -- h : 30 m : 15 s

- Gewünschte Spielzeit mit »1 ... 0« eingeben und mit »OK« bestätigen.
Beispiele: 30 Minuten, 15 Sekunden – Eingabe »3« »0« »1« »5«.
1 Stunde, 5 Minuten, 30 Sekunden – Eingabe »1« »0« »5« »3« »0«.

Hinweis:

Wurde die falsche Zeit eingegeben, kann diese mit »C CLEAR« gelöscht werden.

- Eingabe mit »OK« bestätigen.
– Der DVD-Player sucht den Abschnitt und beginnt die Wiedergabe.

Kapitel direkt anwählen

Suche
05

- Nächstes Kapitel anwählen, dazu während der Wiedergabe »▶▶|« wiederholt drücken.

Suche
02

- Anfang des laufenden Titel wählen, dazu »|◀◀« kurz drücken.
Vorherige Titel wählen, dazu »|◀◀« wiederholt drücken.

WIEDERGABE EINER DVD/VIDEO-CD

Einen Abschnitt, einen Titel oder eine DVD wiederholen (Repeat)

Bei diesen Funktionen wird der momentan laufende Abschnitt, der momentan laufende Titel oder die gesamte DVD wiederholt.

Alle wiederholen

Titel-Wiederholung

Kapitel-Wiederholung

Löschen

- Während der Wiedergabe »REPEAT« ein- zwei- oder dreimal drücken.
– Die gewählte Funktion wird kurz angezeigt:
»Alle wiederholen« – die DVD wird wiederholt;
»Titel-Wiederholung« – der aktuelle Titel der DVD wird wiederholt;
»Kapitel-Wiederholung« – das aktuelle Kapitel der DVD wird wiederholt.

- Funktion beenden, dazu »REPEAT« ein viertes mal drücken.
– Anzeige »Löschen« – die Funktion wird beendet.

Eine ausgesuchte Szene wiederholen (A-B Repeat)

Bei dieser Funktion wird Anfang und Ende einer Szene markiert, diese wird wiederholt abgespielt.

A- Wiederholen

A-B Wiederholen

Löschen

- Während der Wiedergabe den Anfang der Szene mit »REPEAT A-B« markieren.
– In der Anzeige des DVD-Spielers erscheint »REPEAT A-B«, am Bildschirm erscheint »A-Wiederholen«.

- Ende der Szene markieren, dazu »REPEAT A-B« erneut drücken.
– Die markierte Szene wird andauernd wiederholt.

- Funktion beenden, dazu »REPEAT A-B« erneut drücken.

WIEDERGABE EINER AUDIO-CD

Einen Titel oder eine CD wiederholen (Repeat)

Bei diesen Funktionen wird der momentan laufende Titel oder die gesamte CD wiederholt.



- 1 Während der Wiedergabe »REPEAT« drücken.
– Anzeige: »REPEAT ALL«, der Inhalt der CD wird wiederholt.



- 2 Während der Wiedergabe »REPEAT« zweimal drücken.
– Anzeige: »REPEAT 1«, der momentan laufende Titel wird wiederholt.

- 3 Funktion beenden, dazu »REPEAT« erneut drücken.

Einen ausgesuchten Abschnitt wiederholen (A-B Repeat)

Bei dieser Funktion wird Anfang und Ende eines Abschnittes markiert, dieser wird wiederholt abgespielt.



- 1 Während der Wiedergabe Anfang des Abschnittes mit »REPEAT A-B« markieren.

- 2 Ende des Abschnittes markieren, dazu »REPEAT A-B« erneut drücken.
– Der markierte Abschnitt wird andauernd wiederholt.

- 3 Funktion beenden, dazu »REPEAT A-B« erneut drücken.

CD entnehmen

- 1 »▲« am DVD-Player drücken.

KINDERSICHERUNG

Kindersicherung des DVD-Players aktivieren

DVDs können Spielfilme anbieten, deren Inhalt oder auch Szenen nicht für Kinder geeignet sind. Diese DVDs enthalten Informationen, die diesen Inhalt oder diese Szenen markieren und sind mit Kennzahlen von 1 bis 8 versehen. Sie können eine der Kennzahlen auswählen und damit alternative Szenen zur Wiedergabe autorisieren.

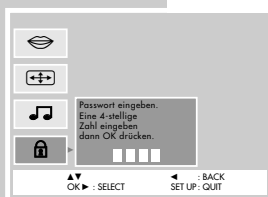

- 1 In „Stopp“ das Hauptmenü mit »SET UP« aufrufen.
– Das Menü wird eingeblendet.

- 2 Zeile »« mit »▼« anwählen und mit »▶« aktivieren.

- 3 Vierstellige Geheimnummer mit »1...0« eingeben und mit »OK« bestätigen.

- 4 Vierstellige Geheimnummer mit »1...0« noch einmal eingeben und mit »OK« bestätigen.
– Ein Untermenü wird eingeblendet, die Zeile »LEVEL« ist markiert.

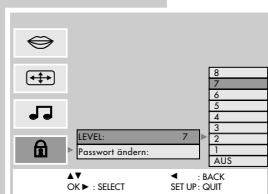

- 4 Untermenü »LEVEL« mit »▶« aktivieren.

- 5 Gewünschte Kennzahl (von 1 bis 8) mit »▲« oder »▼« anwählen und mit »OK« bestätigen.

- 6 Einstellung mit »SET UP« beenden.

Hinweise:

Wird jetzt eine DVD in die Schublade gelegt, die mit der eingegebenen Kennzahl versehen ist, erscheint die Meldung »locked« (gesperrt) und Sie müssen die vierstellige Geheimnummer eingeben.

Zum Abschalten der Funktion die Punkte 1 bis 5 wiederholen und mit »▲« oder »▼« die Anzeige »AUS« wählen.

Falls Sie die Geheimnummer vergessen oder verlegt haben, geben Sie anstelle der „Geheimnummer“ die Ziffern »7« »8« »8« »4« »4« »4« ein.

KINDERSICHERUNG

Geheimzahl ändern

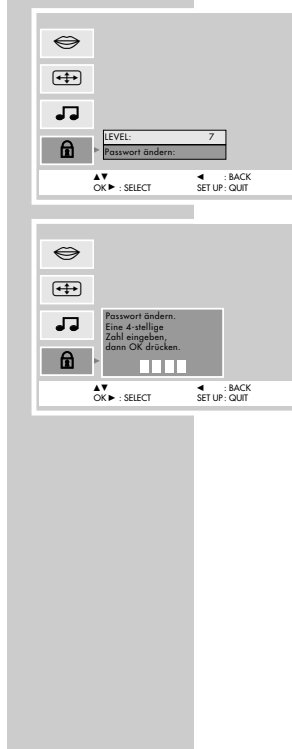



- 1 Hauptmenü mit »SET UP« aufrufen.
– Das Menü wird eingeblendet.
- 2 Zeile »« mit »▼« anwählen und mit »▶« aktivieren.
- 3 Vierstellige Geheimnummer mit »1...0« eingeben und mit »OK« bestätigen.
– Ein Untermenü wird eingeblendet, die Zeile »LEVEL« ist markiert.
- 4 Zeile »Passwort ändern« mit »▼« anwählen und mit »▶« aktivieren.
- 5 Neue vierstellige Geheimnummer mit »1...0« eingeben und mit »OK« bestätigen.
Vierstellige Geheimnummer mit »1...0« nochmal eingeben und mit »OK« bestätigen.
- 6 Einstellung mit »SET UP« beenden.

EINSTELLUNGEN

Einstellungen im Menü »« (Sprache)

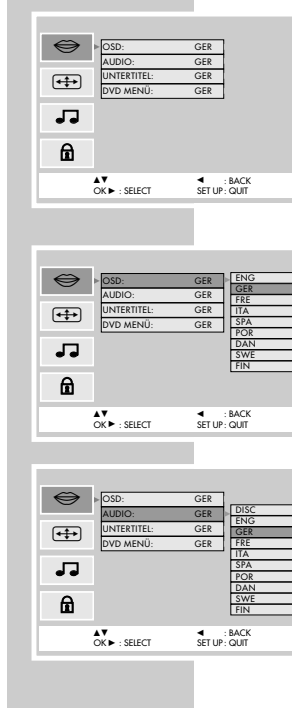
Sie können für bestimmte Wiedergabefunktionen Ihre individuellen Einstellungen im Sprachmenü des DVD-Players wählen.



- 1 In „Stopp“ das Hauptmenü mit »SET UP« aufrufen.
– Das Menü wird eingeblendet.
 - 2 Zeile »« mit »▼« anwählen und mit »▶« aktivieren.
– Ein Untermenü wird eingeblendet.
- Hinweis:**
Die weitere Bedienung entnehmen Sie bitte den folgenden Kapiteln, jeweils ab Pkt. 1.

Sprache der Bildschirmenü des DVD-Players wählen

- 1 Zeile »OSD« mit »▲« oder »▼« anwählen und mit »▶« aktivieren.
- 2 Gewünschte Sprache der Bildschirmenü mit »▲« oder »▼« wählen.
- 3 Menü mit »SET UP« abschalten.

Synchronsprache des Tons wählen

Wenn auf der eingelegten DVD mehrere Sprachen zur Verfügung stehen, wird der Ton in der von Ihnen gewählten Sprache wiedergegeben. Ist die gewählte Synchronsprache auf der DVD nicht vorhanden, schaltet der DVD-Player auf die erste Synchronsprache der DVD.

- 1 Zeile »AUDIO« mit »▲« oder »▼« anwählen und mit »▶« aktivieren.
- 2 Gewünschte Synchronsprache mit »▲« oder »▼« wählen.
- 3 Menü mit »SET UP« abschalten.

EINSTELLUNGEN

Sprache der Untertitel wählen

Wenn auf der eingelegten DVD Untertitel zur Verfügung stehen, werden diese in der von Ihnen gewählten Sprache wiedergegeben. Ist die gewählte Sprache der Untertitel nicht auf der DVD vorhanden, schaltet der DVD-Player auf die erste Sprache der DVD.

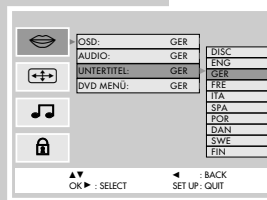

- 1 Zeile »UNTERTITEL« mit »▲« oder »▼« anwählen und mit »▶« aktivieren.
- 2 Gewünschte Sprache mit »▲« oder »▼« wählen.
- 3 Menü mit »SET UP« abschalten.

Hinweis:

Untertitel können während der Wiedergabe mit »SUBTITLE« ein- und ausgeschaltet werden.

Sprache der DVD Menüs wählen

Wenn auf der eingelegten DVD Menüs in verschiedenen Sprachen zur Verfügung stehen, kann die gewünschte Sprache gewählt werden.

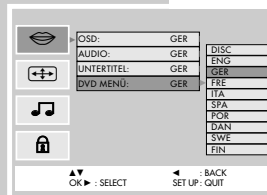

- 1 Zeile »DVD MENU« mit »▲« oder »▼« anwählen und mit »▶« aktivieren.
- 2 Gewünschte Sprache des DVD Menüs mit »▲« oder »▼« wählen.
- 3 Menü mit »SET UP« abschalten.

EINSTELLUNGEN

Einstellungen im Menü »« (Anzeige)

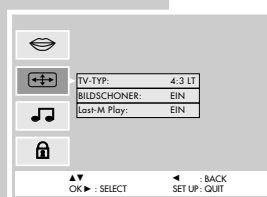

- 1 In „Stopp“ das Hauptmenü mit »SET UP« aufrufen.
– Das Menü wird eingeblendet.
- 2 Zeile »« mit »▼« anwählen und mit »▶« aktivieren.
– Ein Untermenü wird eingeblendet.

Hinweis:

Die weitere Bedienung entnehmen Sie bitte den folgenden Kapiteln, jeweils ab Pkt. 1.

Format des Fernsehgerätes

Haben Sie ein Fernsehgerät mit dem Bildformat 4:3, dann brauchen Sie keine Einstellung vornehmen, die Einstellung 4:3 ist voreingestellt.

Sie können ein anderes Format wählen:

– »4:3 Letterbox«, für eine Breitbild-Wiedergabe mit schwarzen Balken am oberen und unteren Bildschirmrand des Fernsehgerätes,

oder

– »16:9«, für Fernsehgerät mit dem Bildformat 16:9.

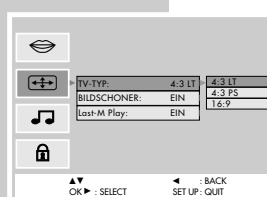

- 1 Zeile »TV-TYP« mit »▲« oder »▼« anwählen und mit »▶« aktivieren.
- 2 Benötigtes Bildformat »4:3 LT« oder »4:3 PS« oder »16:9« mit »▲« oder »▼« wählen.
- 3 Menü mit »SET UP« abschalten.

EINSTELLUNGEN

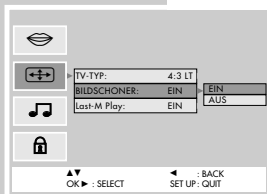

Bildschoner ein-/ausschalten

- 1 Zeile »BILDSCHONER« mit »▲« oder »▼« anwählen und mit »▶« aktivieren.
- 2 Funktion mit »▲« oder »▼« ein-/oder ausschalten.
- 3 Menü mit »SET UP« abschalten.

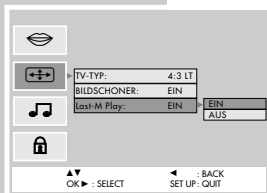

Funktion Last-Memory ein-/ausschalten

- 1 Zeile »Last-M-Play« mit »▲« oder »▼« anwählen und mit »▶« aktivieren.
- 2 Funktion mit »▲« oder »▼« ein-/oder ausschalten.
- 3 Menü mit »SET UP« abschalten.

Einstellungen im Menü »🎵« (Ton)

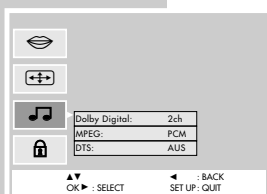

- 1 In „Stopp“ das Hauptmenü mit »SET UP« aufrufen.
– Das Menü wird eingeblendet.
- 2 Zeile »🎵« mit »▼« anwählen und mit »▶« aktivieren.
– Ein Untermenü wird eingeblendet.

Hinweis:

Die weitere Bedienung entnehmen Sie bitte den folgenden Kapiteln, jeweils ab Pkt. 1.

EINSTELLUNGEN

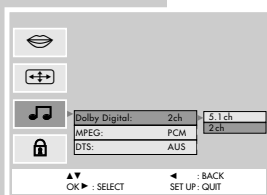

Tonarten für den Digitalausgang wählen

- 1 Zeile »Dolby Digital« mit »▲« oder »▼« anwählen und mit »▶« aktivieren;
- 2 Gewünschtes Format mit »▲« oder »▼« wählen.
- 3 Menü mit »SET UP« abschalten.

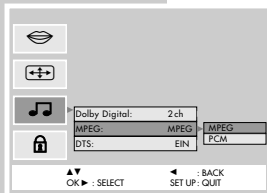

Digitales Tonformat für den Digitalausgang wählen

- 1 Zeile »MPEG« mit »▲« oder »▼« anwählen und mit »▶« aktivieren;
- 2 Gewünschtes Format mit »▲« oder »▼« ein-/oder ausschalten.
- 3 Menü mit »SET UP« abschalten.

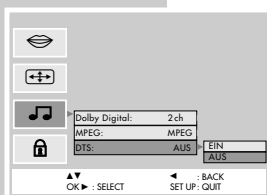

DTS-Tonsignal für den Digitalausgang ein-/ausschalten

- 1 Zeile »DTS« mit »▲« oder »▼« anwählen und mit »▶« aktivieren;
- 2 DTS-Tonsignal mit »▲« oder »▼« ein-/oder ausschalten.
- 3 Menü mit »SET UP« abschalten.









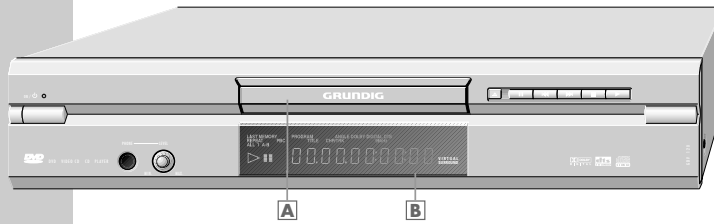

Operating Hints

This chapter contains excerpts from the user manual. For further particulars please refer to the appropriate user manual the part number of which is indicated in the spare parts list.

OVERVIEW

The front of the DVD player



-  Switches the DVD player to and from Stand-by mode. Switching the DVD player off does not completely separate it from the mains.
-  Stand-by display.
- PHONE** Headphone socket for connecting a stereo headphone set with a jack plug (ø 6.3 mm).
- LEVEL** Adjusts the volume for headphones connected to the »PHONE« socket.
-  Compartment for DVDs/CDs.
-  Display.
-  Indicator light for Virtual Surround function.
-  Opens and closes the disc compartment.
-  Freeze-frame for DVDs and video CDs; pause for audio CDs.
-  Selects the previous title or section during playback.
-  Selects the next title or section during playback.
-  Interrupts the current, switches to "STOP".
-  Starts playback.

OVERVIEW

The DVD player display

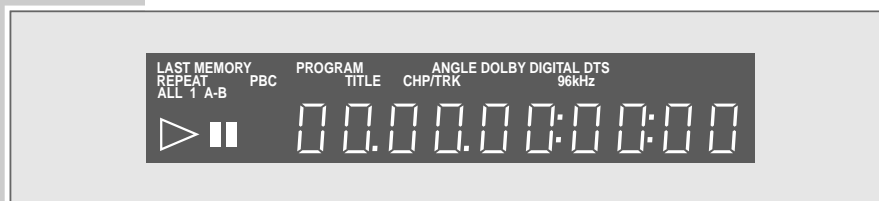

- »LAST MEMORY« Function is activated.
- »PBC« Video CD in use.
- »PROGRAM« Function is activated.
- »01 TITLE« Number of the title of a DVD.
- »01 CHP/TRK« Number of the chapter (CHP) on a DVD or CD, or number of the title (TRK) on a DVD, or number of the track on a CD.
- »ANGLE« Angle function is activated.
- »DOLBY DIGITAL« The DVD provides a Dolby Digital audio signal.
- »DTS« The DVD provides a DTS audio signal.
- »96 kHz« Audio clock frequency 96 kHz.
- »00:00:00« Total or elapsed playing time in hours, minutes and seconds.
- »REPEAT ALL 1 A-B« One of the Repeat functions is activated.
- »|||« Pause/Freeze-Frame.
- »▷« Playback.

OVERVIEW

The back of the DVD player

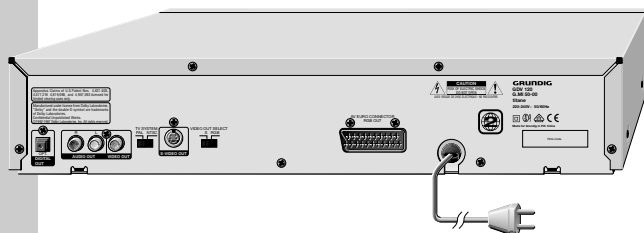

- OPT. DIGITAL OUT** Audio output socket (optical) for PCM/MPEG2/AC3/DTS signals, for connecting to a digital HiFi system.
- R AUDIO OUT L** Audio output sockets (right/left channel) for connecting a HiFi system.
- VIDEO OUT** Video output socket for connecting a television with a video socket.
- TV SYSTEM PAL NTSC** For specifying the TV system (PAL or NTSC).
- S-VIDEO OUT** Video output socket for connecting a television with S-VHS socket.
- VIDEO OUT SELECT S RGB** Switches the video output signal to the »A/V EURO CONNECTOR« or »S-VIDEO OUT« socket.
- A/V EURO CONNECTOR** Video/audio output socket for connecting a television.
-  Mains cable.



Caution:

Do not connect any devices while the DVD player is switched on.
 Never touch the inside of the sockets and plugs of the connecting cables.
 An electrostatic discharge can damage the DVD player.

OVERVIEW

The remote control



-  **ON** Switches the DVD player to and from Stand-by mode.
The display on the DVD player is red in Stand-by mode.
- PICTURE MODE** For adjusting the picture during playback.
- LAST MEMO** Selects a position on the DVD during playback.
- VIRTUAL SURROUND** Activates the Virtual Surround function.
- OSD** Displays/conceals the menus on the television screen.
- SUBTITLE** Displays subtitles during DVD playback.
- AUDIO** Switches between original and dubbed language during DVD playback.
- TITLE** Calls up the main menu during DVD/video CD playback (depends on DVD).
- MENU** Calls up the DVD/video CD title menu during playback.
- ZOOM** Enlarges freeze-frames.
- SETUP** Calls up the DVD player's »main« menu (in STOP mode).
-  **◀ ▶ ▼** Select various functions in the menus.
- OK** Confirms menu entries.
- RETURN** Calls up the previous DVD menu.

OVERVIEW



- ◀◀ Switches to backwards frame search at various speeds during playback.
- ▶▶ Switches to forwards frame search at various speeds during playback.
- ◀◀ Switches to backwards with DVDs and video CDs.
- ⏸ Freeze-frame for DVDs and video CDs; pause for audio CDs.
- Terminates all functions, switches the DVD player to "STOP".
- ▶▶ Slow-motion with DVDs.
- ◀◀ ▶▶ Select the previous or next title/chapter during playback.
- ▶ Starts playback.
- C CLEAR** Deletes the title or chapter from the program.
- 1 ... 0** Numeric keys for various inputs.
- PROGRAM** For programming titles or chapters.
- SEARCH MODE** For selecting titles or chapters.
- ANGLE** Selects various camera angles for certain scenes or passages of the DVD during playback.
- ANGLE REPLAY** Repeats the selected angle.
- BOOKMARK** Selects scenes on the DVD.
- REPEAT** Repeats sections, titles or DVDs/CDs.
- A-B REPEAT** Repeats selected sections.

CONNECTION AND PREPARATION

Connecting to a television...

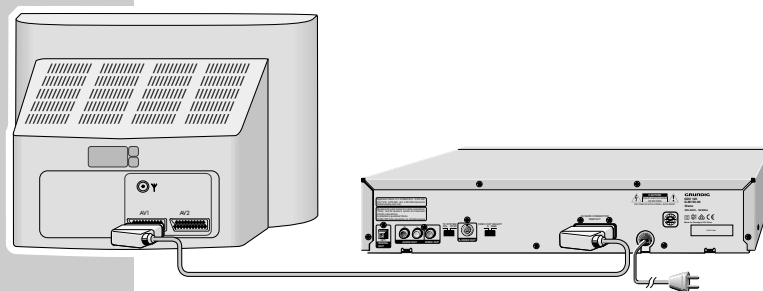

... with a EURO-AV cable

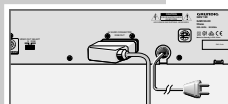

- 1 Plug the supplied EURO-AV cable into the »A/V EURO CONNECTOR« socket on the DVD player and into the AV 1 socket on the television, and switch the »VIDEO OUT SELECT S RGB« switch to »RGB«;

or

... with a cinch cable

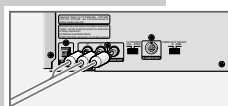

- 1 Plug a standard cinch cable into the »VIDEO OUT« socket on the DVD player and into the VIDEO IN socket on the television.
- 2 Plug a standard cinch AV cable into the »R AUDIO L« sockets of the DVD player and into the AUDIO IN sockets of the television,

or

CONNECTION AND PREPARATION



... with a Y/C cable (S-VHS)

- 1 Plug a standard cinch AV cable into the »R AUDIO L« sockets of the DVD player and into the AUDIO IN sockets of the television.
- 2 Plug a standard Y/C cable into the »S-VIDEO OUT« socket on the DVD player and into the S-VIDEO IN socket on the television, and switch the »VIDEO OUT SELECT S RGB« switch to »S«.

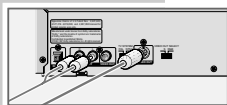

Note:

If the DVD player is connected to a television set with a 16:9 format, observe the settings described in the "Television format" section on page 38.

The colour norm of the DVD player's screen menus has to be adapted to the format of the television.

Set the »TV SYSTEM« switch of the DVD player to »PAL« (television with PAL norm) or »NTSC« (television with NTSC norm).

Connecting to a HiFi system with analog two-channel stereo sound

As an alternative to using the television's speakers, the sound can also be played back through a HiFi system.

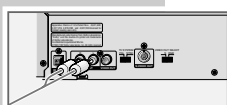

- 1 Plug a standard cinch cable into the »R AUDIO L« sockets of the DVD player and into the appropriate sockets of the HiFi system.

Caution:

The DVD player's »R AUDIO L« sockets may not be connected to the PHONO sockets (record player input) of the HiFi system.

Note:

The »R AUDIO L« sockets can also be used for connection to a Pro Logic audio/video receiver.

CONNECTION AND PREPARATION

Connecting to a digital multi-channel audio/video amplifier

The digital multi-channel sound of a DVD can best be decoded and played with a multi-channel audio/video receiver (MPEG 2 multi-channel decoder or Dolby* digital decoder).



- 1 Plug a standard optical cable into the »OPT. DIGITAL OUT« socket on the DVD player and into the appropriate socket on the digital multi-channel amplifier.

* Manufactured under license from Dolby Laboratories Licensing Corporation. "Dolby", "Dolby Pro Logic", "AC 3" and the double-D symbol "DD" are trademarks of the Dolby Laboratories Licensing Corporation. Copyright 1992 Dolby Laboratories, Inc. All rights reserved.

Note:

You have to activate the digital output on the DVD player and set the correct digital output format (MPEG or PCM). Make sure to observe the settings described in the "Settings in the »Ton« menu" section on Page 39.

The audio/video receiver has to be able to process the DTS audio signal in order to play a DVD with DTS. If it cannot, then you will not be able to hear the DVD.

Connecting headphones

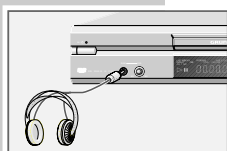







- 1 Plug the headphone plug into the »PHONE« socket on the DVD player.

Note:

The volume of the headphones is adjusted with the »LEVEL« knob.

DVD/VIDEO CD PLAYBACK

Playing back a title

-  1 After the disc compartment closes and the DVD is scanned, playback starts automatically.
-  2 To switch to playback-pause (freeze-frame), press »«.
-  3 To resume playback, press »«.
-  4 To end playback, press »«.

Note:

Depending on the DVD/video CD you are using, you may have to select a title or chapter from the DVD's/video CD's table of contents.

To select, use the »« or »« keys; to activate, use the »**OK**« key.

If the selections are numbered, use the »**1 ... 0**« keys.

If the »« symbol appears on the television screen, then the selected function is not possible with this DVD/video CD.

Calling up the function display

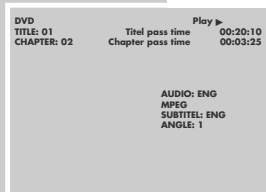

Every function you select can be displayed on the screen (playing time, current title, etc.).

- 1 To display the function, press »**OSD**«.
- 2 To hide the function display, press »**OSD**« again.

DVD/VIDEO CD PLAYBACK

Selecting titles or chapters ...

If a DVD/video CD contains several titles and/or chapters, you can select from among them.

... with the menu of the DVD player

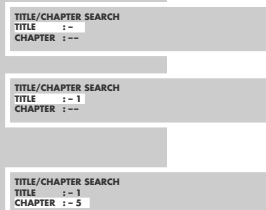

- 1 Display the menu by pressing »**SEARCH MODE**«. – The »TITLE« line is highlighted.
- 2 Enter the one or two-digit title number with the »**1 ... 0**« buttons.
- 3 Select the »CHAPTER« line with »«.
- 4 Enter the one or two-digit chapter number with the »**1 ... 0**« buttons.

Note:

If you enter the wrong number, you can delete it by pressing »**CLEAR**«.

- 5 Confirm your entry with »**OK**«. – Playback starts with the selected title or chapter.

Note:

If the »« symbol appears, then this function is not possible with this DVD/video CD.

... with the title menu of the DVD/video CD

The title menu of the DVD/video CD may contain selection options for titles, sections or scenes.

- 1 Call up the contents of the DVD/video CD by pressing »**MENU**«. – If the DVD/video CD possesses a title menu, it appears on the screen.

DVD/VIDEO CD PLAYBACK

- 2 If the selection options are numbered, select the desired title and section with »1 ... 0«.
- 3 If the options are not numbered, select titles and sections with »▲«, »▼«, »◀« or »▶«, and activate with »OK«.

Selecting a section to the nearest minute

TITLE/CHAPTER SEARCH
TITLE : --
CHAPTER : --

- 1 Display the menu by pressing »SEARCH MODE«.
– The »TITLE« line is highlighted.

TIME SEARCH
TIME : -- h : -- m : -- s

- 2 Press »SEARCH MODE« again.
– The »TIME SEARCH« line appears.

TIME SEARCH
TIME : -- h : 30 m : 15 s

- 3 Enter the desired playing time with »1 ... 0« and confirm with »OK«.
Example: 30 minutes, 15 seconds – enter »3« »0« »1« »5«.
1 hour, 5 minutes, 30 seconds – enter »1« »0« »5« »3« »0«.

Note:

If you enter the wrong time, you can delete it by pressing »C CLEAR«.

- 4 Confirm your entry with »OK«.
– The DVD player locates the section and starts playback.

Selecting a chapter directly

Search
05

- 1 To select the next chapter, press »▶▶|« repeatedly during playback.

Search
02

- 2 To select the beginning of the current title, briefly press »|◀◀«.
To select previous titles, press »|◀◀« repeatedly.

DVD/VIDEO CD PLAYBACK

Repeating a section, a title or a DVD (Repeat)

These functions repeat the currently running section, title, or the entire DVD.

All Repeat

- 1 Press »REPEAT« once, twice or three times during playback.
– The selected function is briefly displayed:
»All Repeat« – the DVD is repeated;
»Title Repeat« – the current title of the DVD is repeated;
»Chapter Repeat« – the current chapter of the DVD is repeated.

Title Repeat

- 2 To stop this function, press »REPEAT« a fourth time.
– The display reads: »Clear« – the function is stopped.

Chapter Repeat

Clear

Repeating a selected scene (A-B Repeat)

You can use this function to select the beginning and end of a scene, and then play it over and over.

Repeat A -

- 1 During playback, mark the beginning of the scene with »REPEAT A-B«.
– »REPEAT A-B« appears on the DVD player display, and »Repeat A-« appears on the screen.

Repeat A - B

- 2 To mark the end of the scene, press »REPEAT A-B« again.
– The selected scene is repeated over and over.

Clear

- 3 To stop this function, press »REPEAT A-B« again.

AUDIO CD PLAYBACK

Repeating a track or a CD (Repeat)

These functions repeat the current track or the entire CD.



- 1 Press »REPEAT« during playback.
– The display reads: »All Repeat«, and the CD is repeated from the beginning.



- 2 During playback, press »REPEAT« twice.
– The display reads: »Repeat 1«, and the current track is repeated.

- 3 To stop this function, press »REPEAT« again.

Repeating a selected section (A-B Repeat)

You can use this function to select the beginning and end of a selection, and then play it over and over.



- 1 During playback, mark the beginning of the section with »REPEAT A-B«.

- 2 To mark the end of the section, press »REPEAT A-B« again.
– The selected section is repeated over and over.

- 3 To stop this function, press »REPEAT A-B« again.

Removing the CD

- 1 Press »▲« on the DVD player.

PARENTAL CONTROL SYSTEM

Activating the DVD player's parental control system

DVDs may offer films whose content or individual scenes are not appropriate for children. These DVDs contain information which identifies these scenes, providing them with ratings from 1 to 8. You can select one of the ratings and thereby authorise alternative scenes for playback.

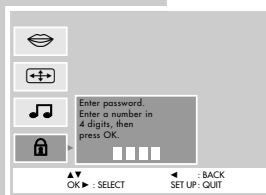

- 1 In "Stop" mode, call up the main menu with »SET UP«.
– The menu appears.
- 2 Select the »LEVEL« line with »▼« and press »▶« to activate.
- 3 Enter the four-digit code number with »1...0« and confirm with »OK«.
– A submenu appears with the »LEVEL« line highlighted.

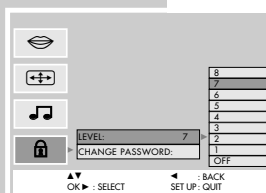

- 4 Activate the »LEVEL« submenu with »▶«.
- 5 Select the desired rating (1 to 8) with »▲« or »▼«, and press »OK« to confirm.
- 6 Conclude the setting by pressing »SET UP«.

Note:

If a DVD with the rating you selected is loaded into the player, the message »locked« appears, and you have to enter the four-digit code number.

Note:

To deactivate this function, repeat steps 1 to 5 and press »▲« or »▼« to select »Off«.

If you forget or lose the code number, enter the digits »7« »8« »8« »4« »4« »4«.

PARENTAL CONTROL SYSTEM

Changing the code number

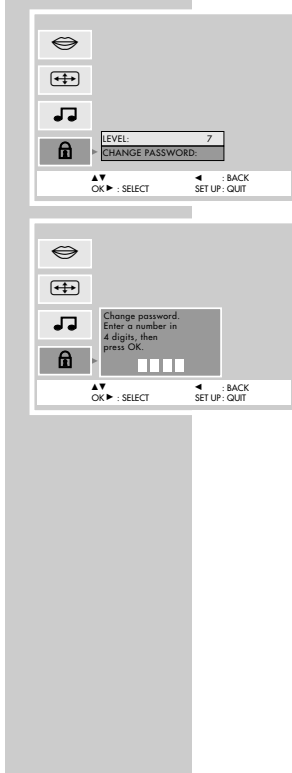



- 1 Call up the main menu with »SET UP«.
– The menu appears.
- 2 Select the »« line with »▼« and press »▶« to activate.
- 3 Enter the four-digit code number with »1...0« and confirm with »OK«.
– A submenu appears with the »LEVEL« line highlighted.
- 4 Select the »CHANGE PASSWORD« line with »▼« and press »▶« to activate.
- 5 Enter the new four-digit code number with »1...0« and confirm with »OK«.
Enter the four-digit code number again with »1...0« and confirm with »OK«.
- 6 Conclude the setting by pressing »SET UP«.

SETTINGS

Settings in the »« menu (Language)

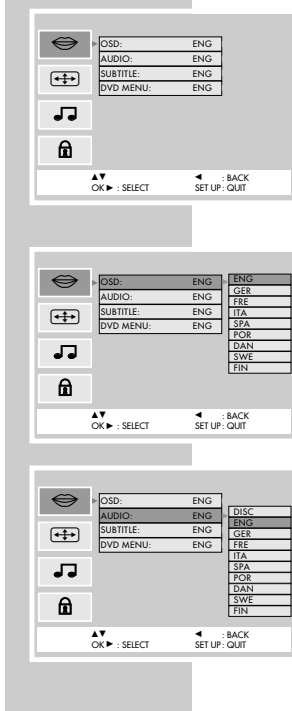
You can select a personal setting for certain playback functions in the Language menu of the DVD player.



- 1 In "Stop" mode, call up the main menu with »SET UP«.
– The menu appears.
 - 2 Select the »« line with »▼« and press »▶« to activate.
– A submenu appears.
- Note:**
For further operation, see the following sections, each one starting from step 1.

Selecting the language of the DVD player's screen menus

- 1 Select the »OSD« line with »▲« or »▼« and press »▶« to activate.
- 2 Select the desired language for the screen menus with »▲« or »▼«.
- 3 Quit the menu with the »SET UP« button.

Selecting the dubbed language

If several languages are available on the DVD, the sound is played back in the language you have selected.
If the language you select is not on the DVD, the first dubbed language available is automatically selected.

- 1 Select the »AUDIO« line with »▲« or »▼« and press »▶« to activate.
- 2 Select the desired dubbed language with »▲« or »▼«.
- 3 Quit the menu with the »SET UP« button.

SETTINGS

Selecting the language of the subtitles

When subtitles are available on the inserted DVD, they are played back in the language you have selected.

If the language you have selected for the subtitles is not on the DVD, the first language available is automatically selected.

- 1 Select the »SUBTITLE« line with »▲« or »▼« and press »▶« to activate.
- 2 Select the desired language with »▲« or »▼«.
- 3 Quit the menu with the »SET UP« button.

Note:

Subtitles can be switched on and off during playback with »SUBTITLE«.

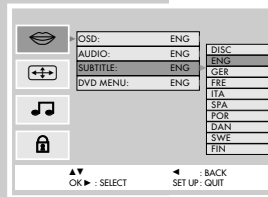

Selecting the language of the DVD menus

If a DVD has menus in several languages, you can select the language of your choice.

- 1 Select the »DVD MENU« line with »▲« or »▼« and press »▶« to activate.
- 2 Select the desired language of the DVD menus with »▲« or »▼«.
- 3 Switch off the menu with the »SET UP« button.

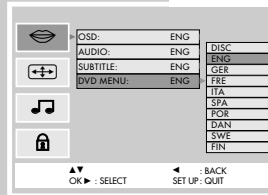

SETTINGS

Settings in the »[+]« menu (Display)

- 1 In "Stop" mode, call up the main menu with »SET UP«.
– The menu appears.
- 2 Select the »[+]« line with »▼« and press »▶« to activate.
– A submenu appears.

Note:

For further operation, see the following sections, each one starting from step 1.

Television format

If you have a television with 4:3 picture format, you do not need to make any changes – 4:3 is the default setting.

You can select a different format:

– »4:3 Letterbox« for letterbox playback with black bars on the top and bottom edges of the screen,

or

– »16:9« for televisions with 16:9 picture format.

- 1 Select the »TV-TYP« line with »▲« or »▼« and press »▶« to activate.
- 2 Select the required picture format, »4:3 LT« or »4:3 PS« or »16:9«, with »▲« or »▼«.
- 3 Quit the menu with the »SET UP« button.

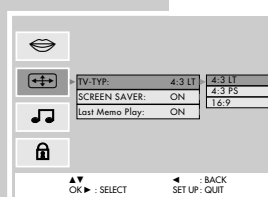
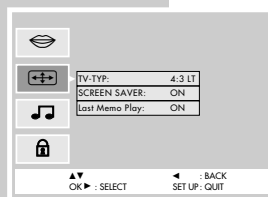

SETTINGS

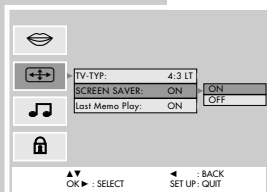

Switching the screen saver on/off

- 1 Select the »SCREEN SAVER« line with »▲« or »▼« and press »▶« to activate.
- 2 Switch the function on/off with »▲« or »▼«.
- 3 Quit the menu with the »SET UP« button.

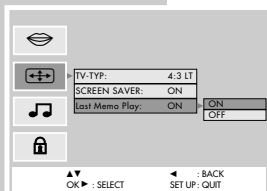

Switching the Last Memory function on/off

- 1 Select the »Last Memo Play« line with »▲« or »▼« and press »▶« to activate.
- 2 Switch the function on/off with »▲« or »▼«.
- 3 Quit the menu with the »SET UP« button.

Settings in the »🎵« menu (Sound)

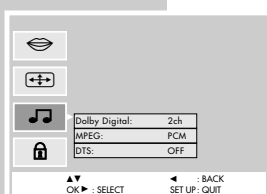

- 1 In "Stopp" mode, call up the main menu with »SET UP«.
– The menu appears.
- 2 Select the »🎵« line with »▼« and press »▶« to activate.
– A submenu appears.

Note:

For further operation, see the following sections, each one starting from step 1.

SETTINGS

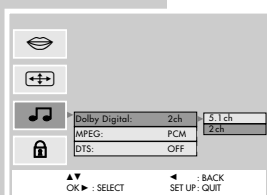

Selecting audio types for the digital output

- 1 Select the »Dolby Digital« line with »▲« or »▼« and press »▶« to activate;
- 2 Select the desired format with »▲« or »▼«.
- 3 Quit the menu with the »SET UP« button.

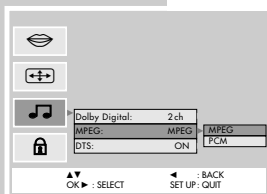

Selecting the audio format for the digital output

- 1 Select the »MPEG« line with »▲« or »▼« and press »▶« to activate;
- 2 Switch the desired format on/off with »▲« or »▼«.
- 3 Quit the menu with the »SET UP« button.

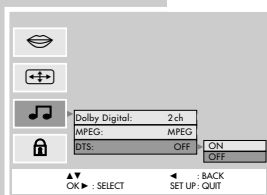

Switching the DTS audio signal for the digital output on/off

- 1 Select the »DTS« line with »▲« or »▼« and press »▶« to activate;
- 2 Switch the DTS audio signal on/off with »▲« or »▼«.
- 3 Quit the menu with the »SET UP« button.

Fehlersuchdiagramm und Blockschaltpläne Trouble Shooting Diagram and Block Circuit Diagrams

Fehlersuchdiagramm

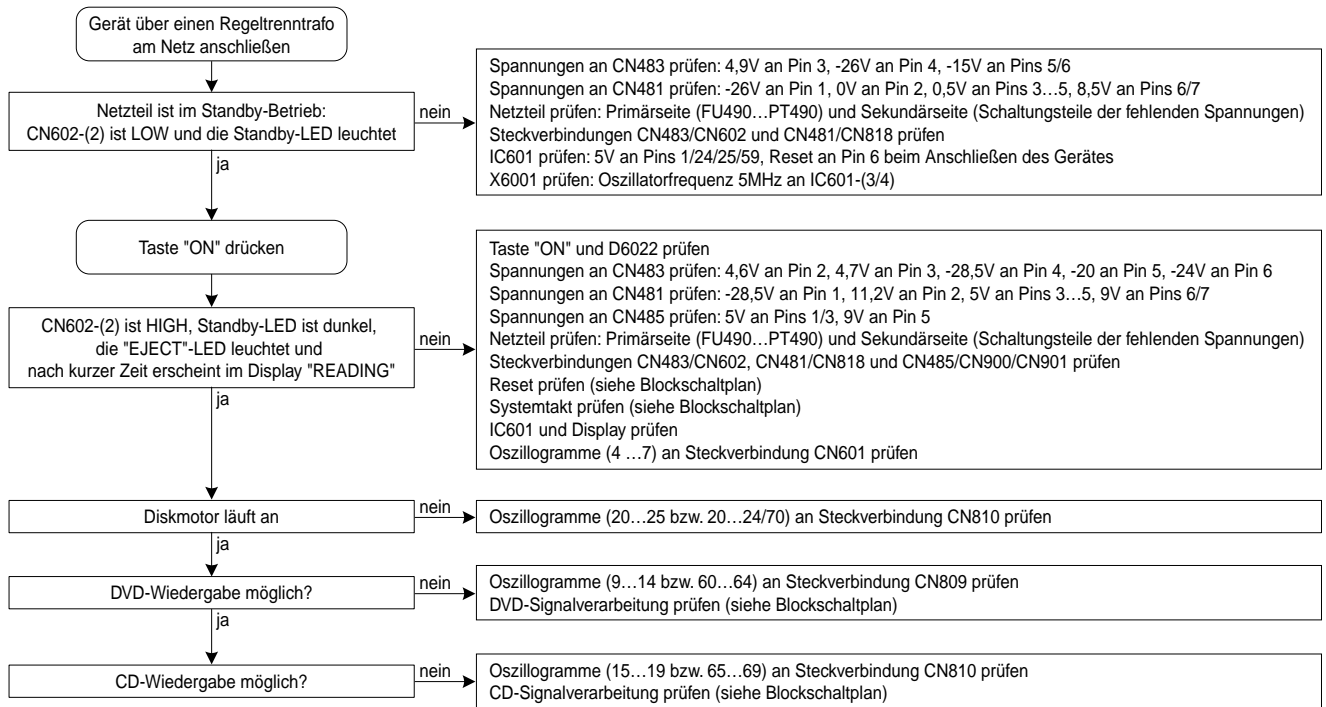

Trouble Shooting Diagram

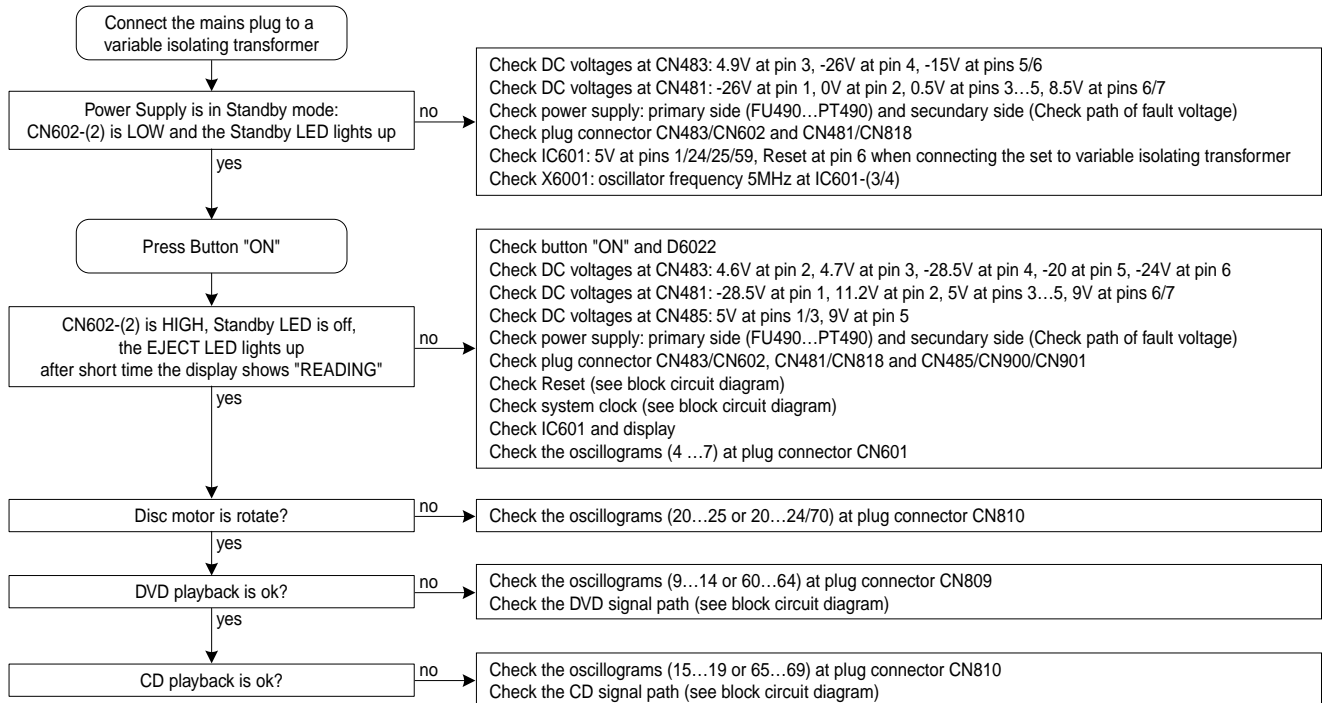

Reset

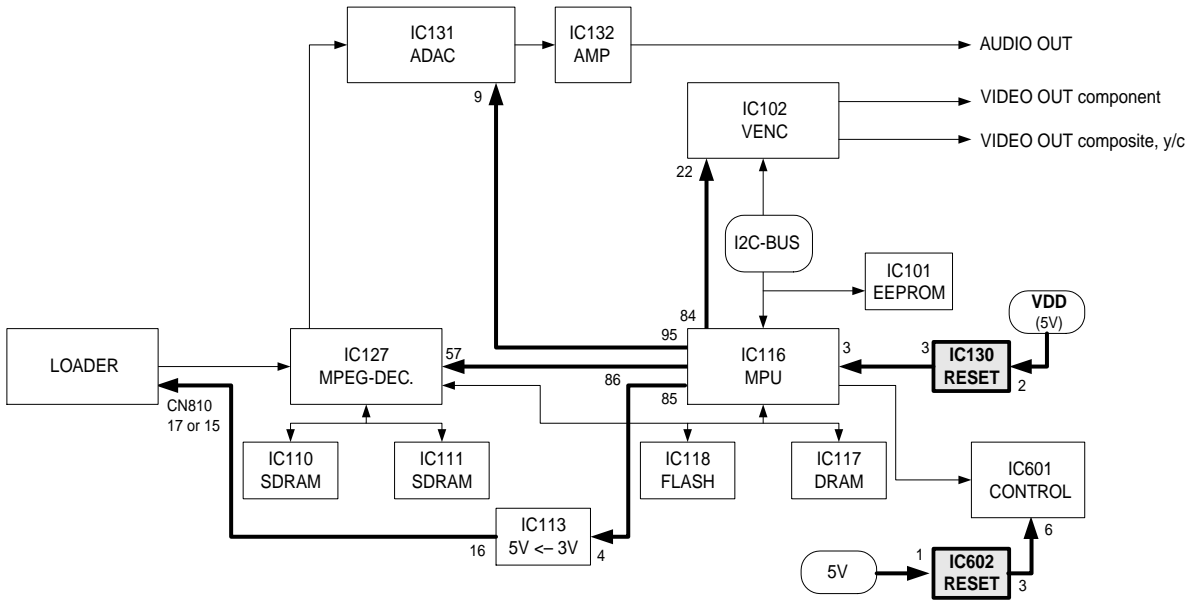

Takt / Clock

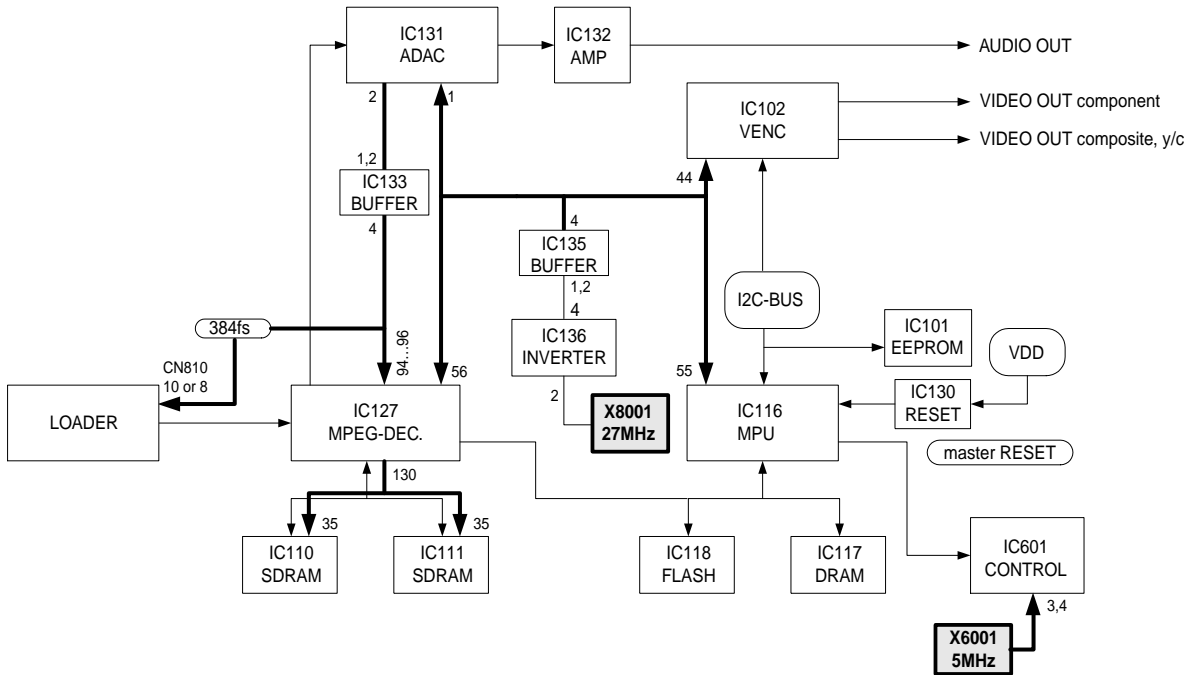

DVD-Signalverarbeitung / Signal Path

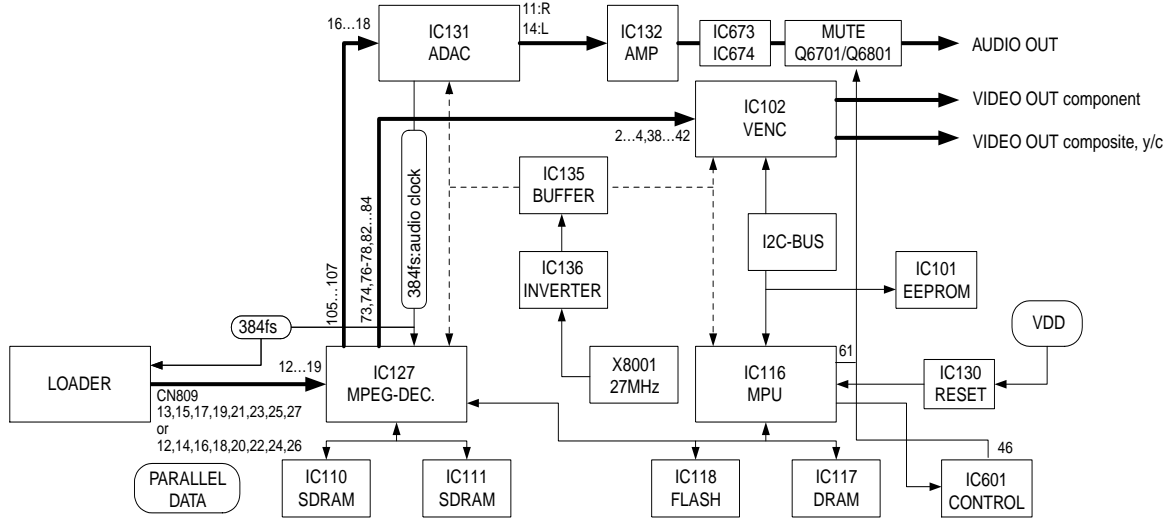

VCD-Signalverarbeitung / Signal Path

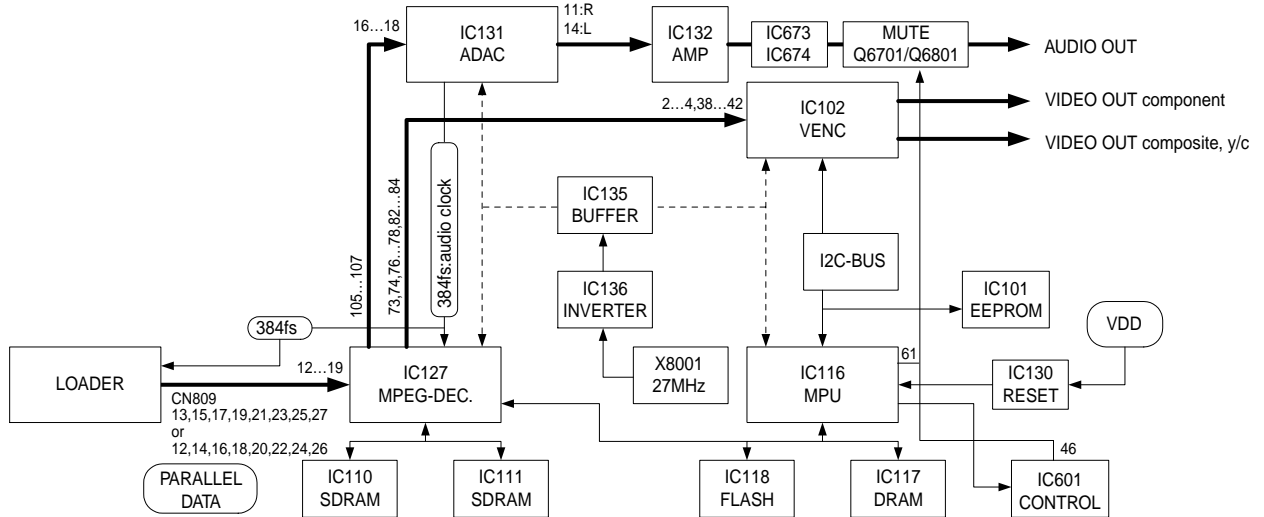

CD-Signalverarbeitung / Signal Path

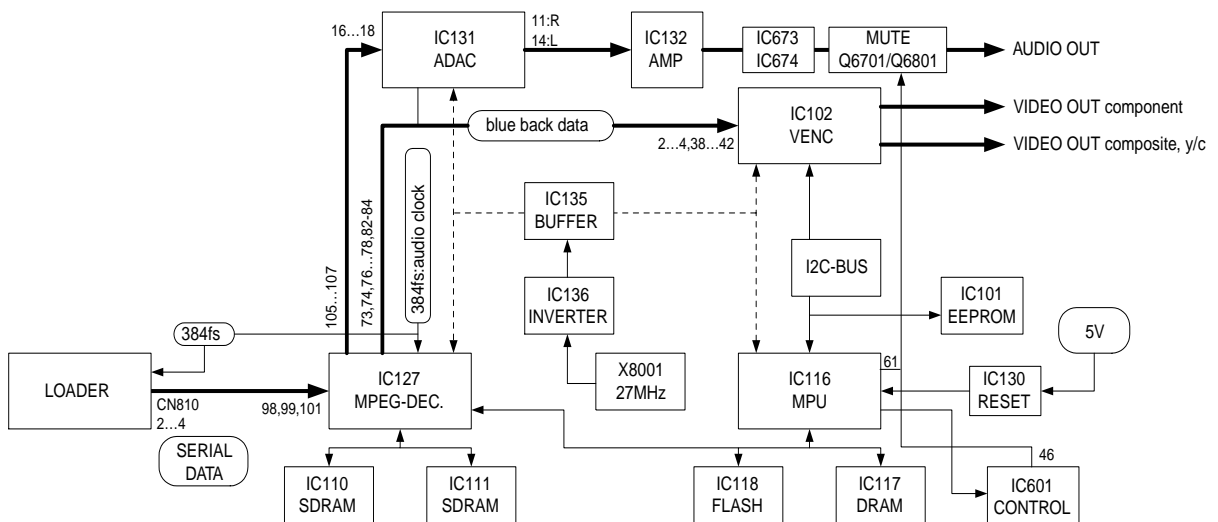

Laufwerksteuerung / Drive Control GDV 120

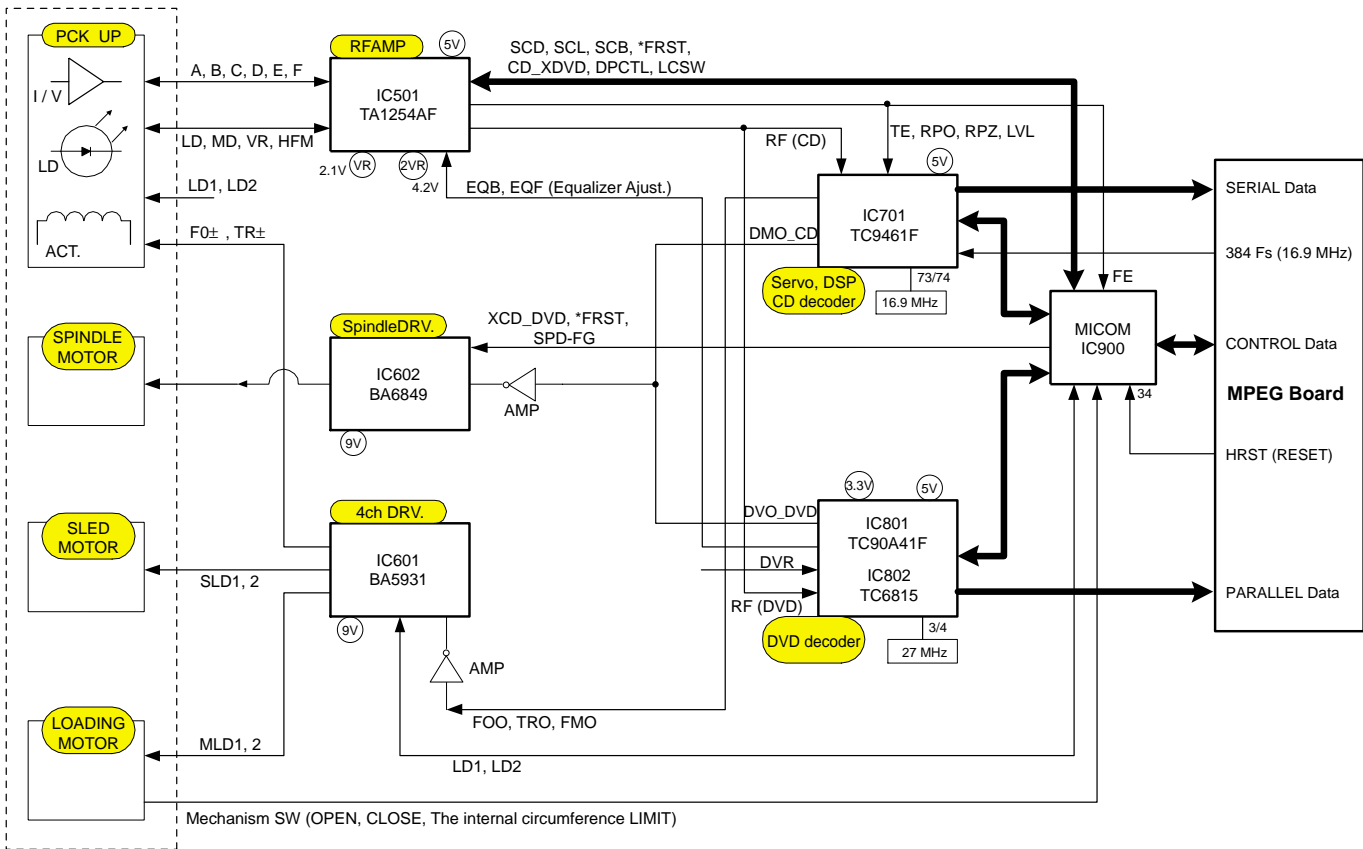

Laufwerksteuerung / Drive Control GDV 120/02

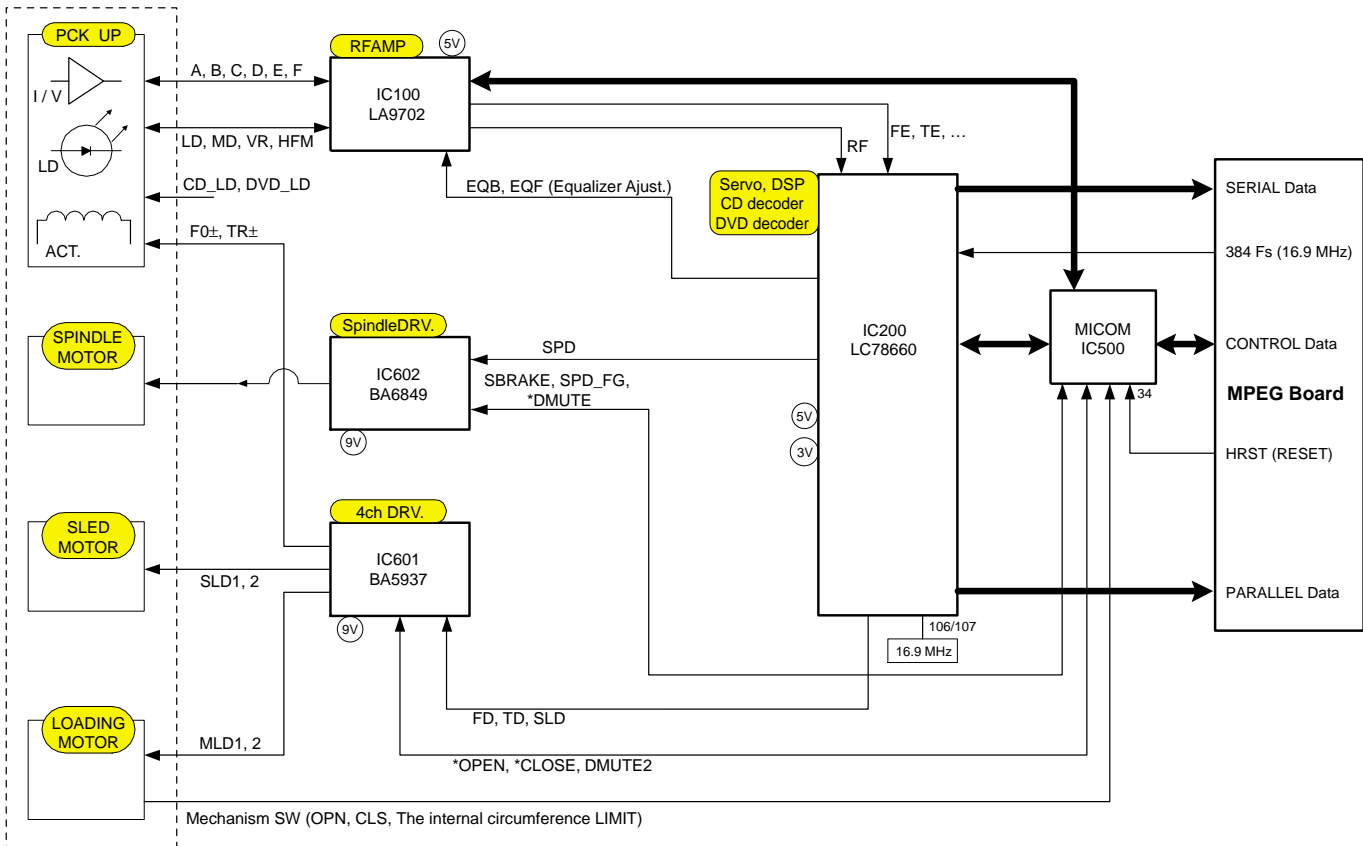

Verdrahtungsplan / Wiring Diagram – GDV 120

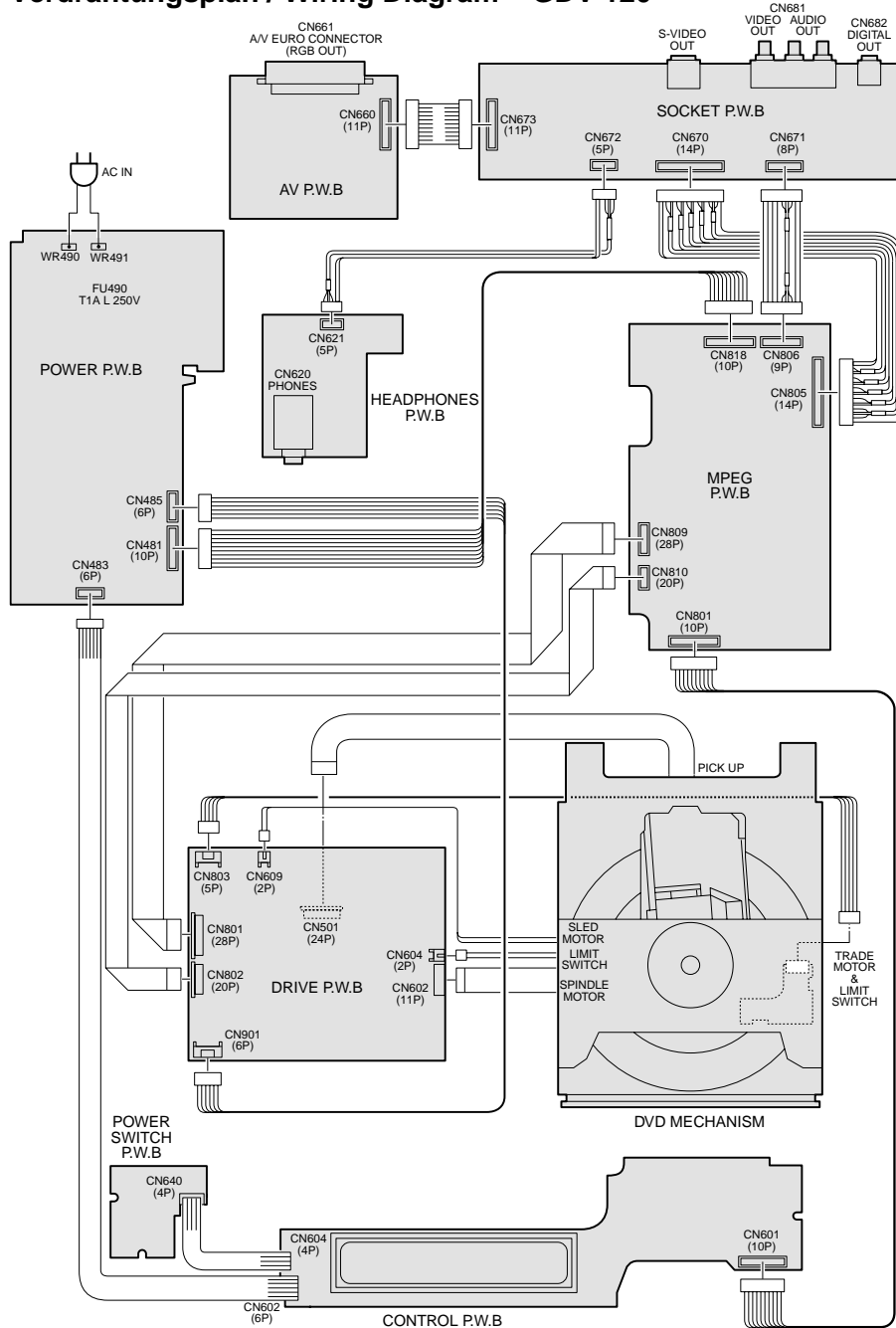

Verdrahtungsplan / Wiring Diagram – GDV 120/02

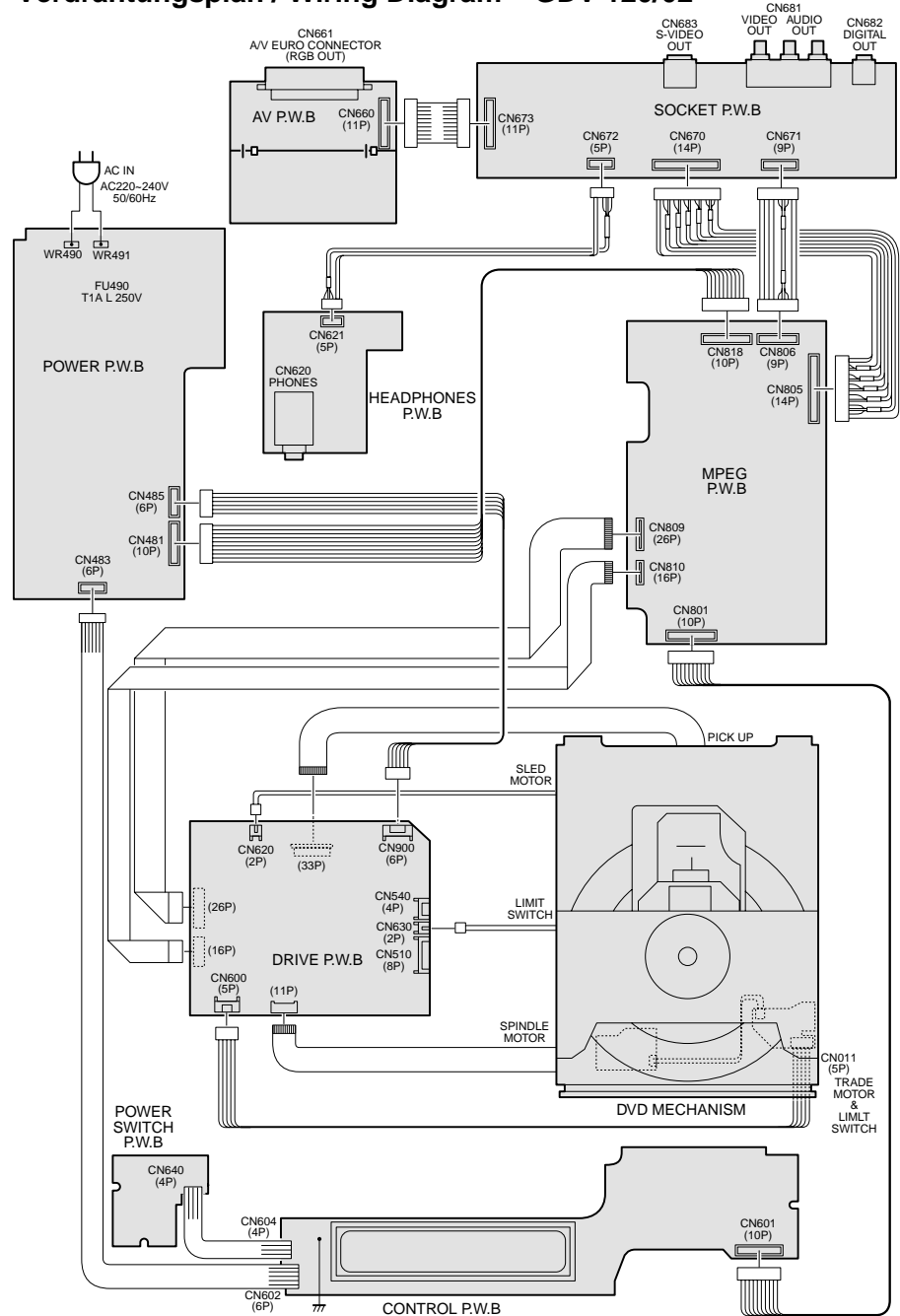

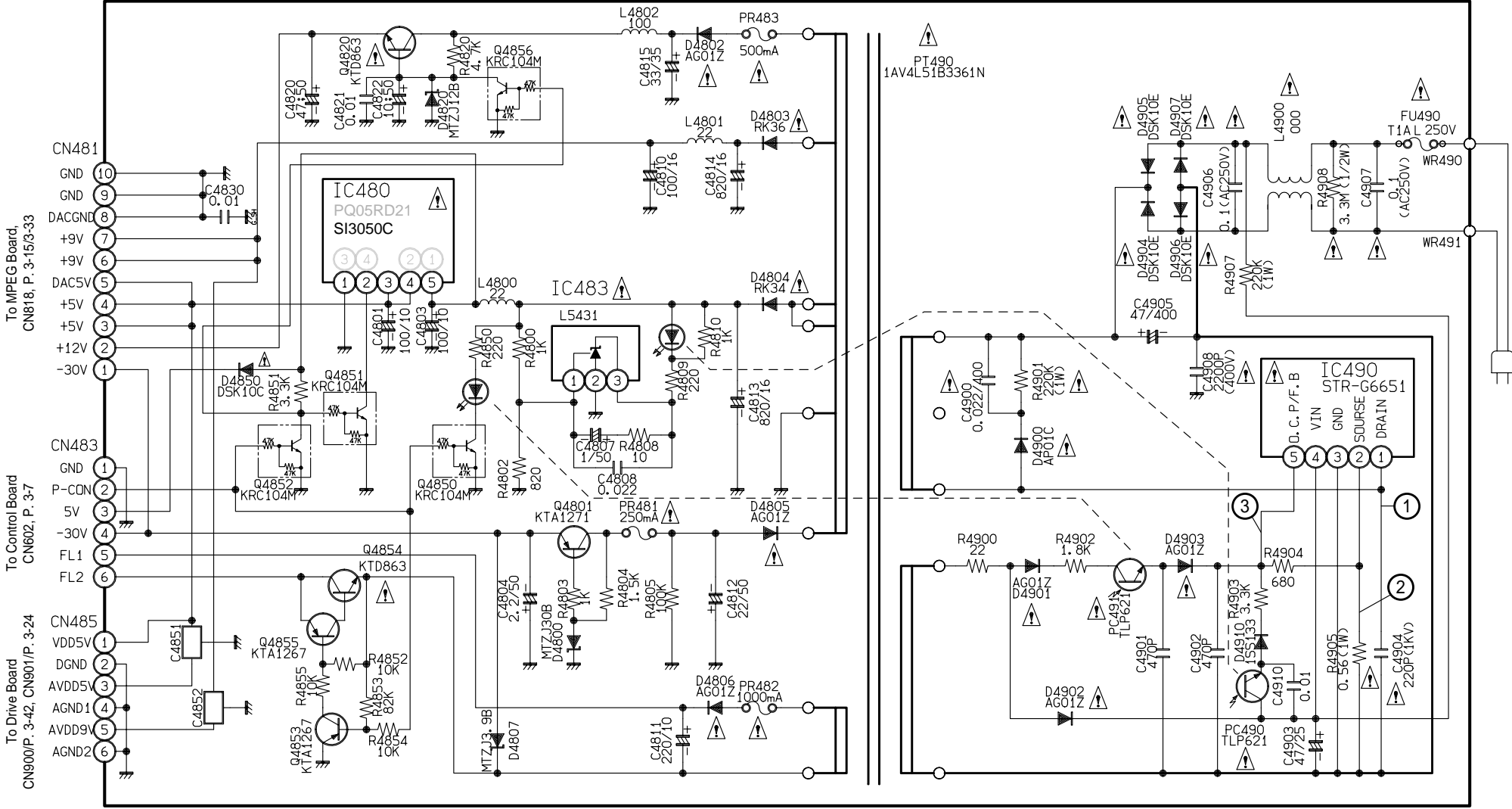

Netzteil / Power Supply

Netzteil / Power Supply

Konventionelle Bestückung – Ansicht von der Lötseite / Conventional Assembly – View of the Solder Side

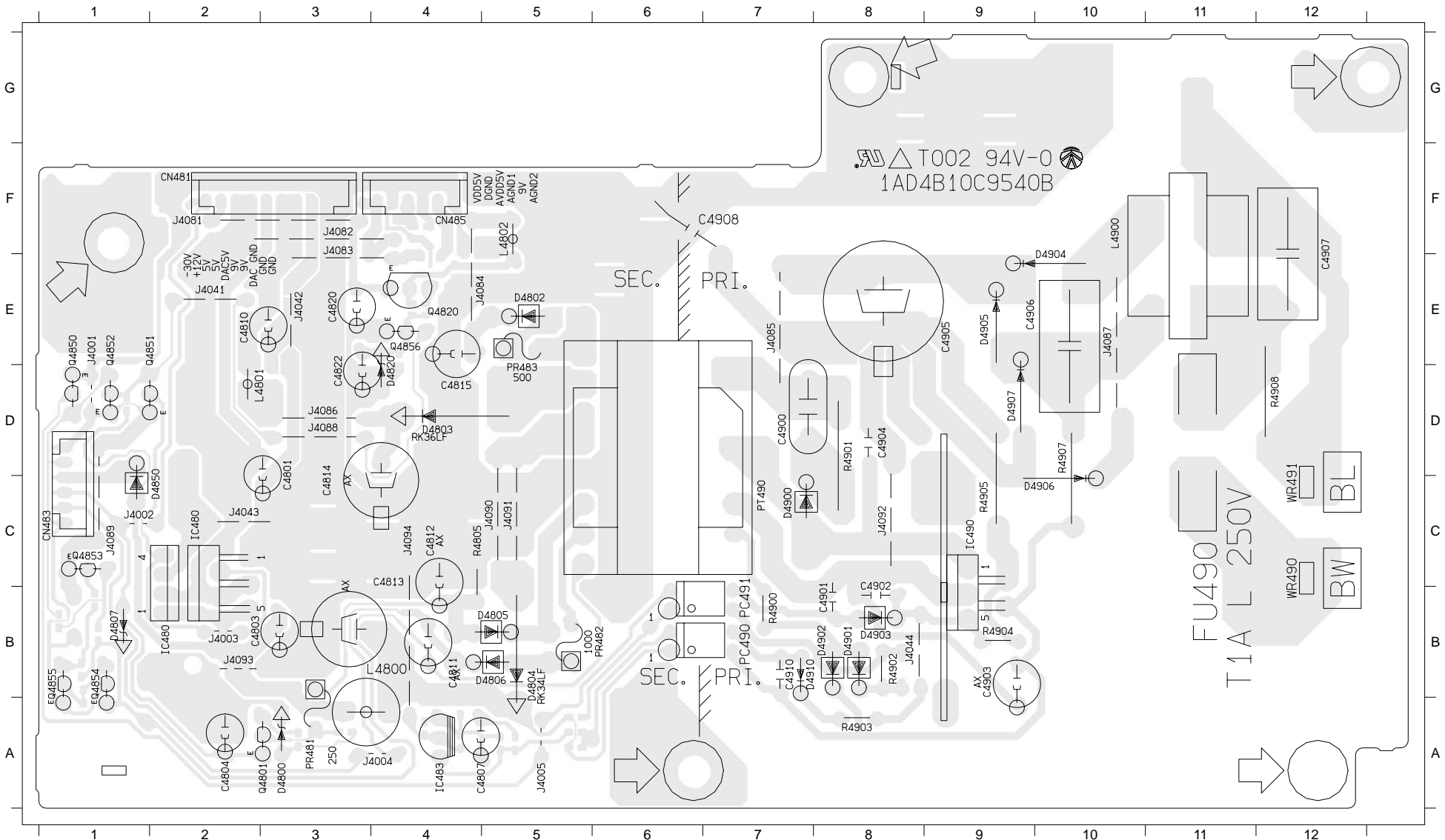

C4801 D 3	C4820 E 3	C4905 E 9	D4804 B 5	D4905 E 9	J4004 A 4	J4086 D 3	L4802 F 5	Q4851 E 2	R4808 A 5	R4901 D 8
C4803 B 2	C4821 E 4	C4906 E 10	D4805 B 5	D4906 C 10	J4005 A 5	J4087 E 10	L4900 F 10	Q4852 E 1	R4809 A 5	R4902 B 8
C4804 A 2	C4822 D 3	C4907 F 12	D4806 B 5	D4907 D 9	J4041 E 2	J4088 D 3	PC490 B 7	Q4853 C 1	R4810 A 5	R4903 A 8
C4807 A 5	C4830 F 2	C4908 F 7	D4807 B 1	D4910 B 8	J4042 E 3	J4089 C 1	PC491 B 7	Q4854 B 1	R4820 E 4	R4904 B 9
C4808 A 5	C4851 F 4	C4910 B 7	D4820 D 4	FU490 B 11	J4043 C 2	J4090 C 5	PR481 A 3	Q4855 B 1	R4850 A 5	R4905 C 9
C4810 E 2	C4852 F 4	CN481 F 2	D4850 C 2	IC480 C 2	J4044 B 8	J4091 C 5	PR482 B 6	Q4856 E 4	R4851 D 1	R4907 D 10
C4811 B 4	C4900 D 7	CN483 C 1	D4900 C 7	IC483 A 4	J4081 F 2	J4092 C 8	PR483 D 5	R4800 A 4	R4852 B 1	R4908 D 12
C4812 C 4	C4901 B 8	CN485 F 4	D4901 B 8	IC490 C 9	J4082 F 3	J4093 B 2	PT490 C 7	R4802 A 4	R4853 B 1	WR490 C 12
C4813 C 4	C4902 C 8	D4800 A 3	D4902 B 8	J4001 E 1	J4083 F 3	J4094 C 4	Q4801 A 3	R4803 A 3	R4854 B 1	WR491 C 12
C4814 C 3	C4903 B 9	D4802 E 5	D4903 B 8	J4002 C 1	J4084 E 5	L4800 B 4	Q4820 E 4	R4804 A 3	R4855 B 1	
C4815 D 4	C4904 D 8	D4803 D 4	D4904 F 10	J4003 B 2	J4085 E 7	L4801 D 3	Q4850 E 1	R4805 C 5	R4900 B 7	

SMD Bestückung – Ansicht von der Lötseite / SMD Assembly – View of the Solder Side

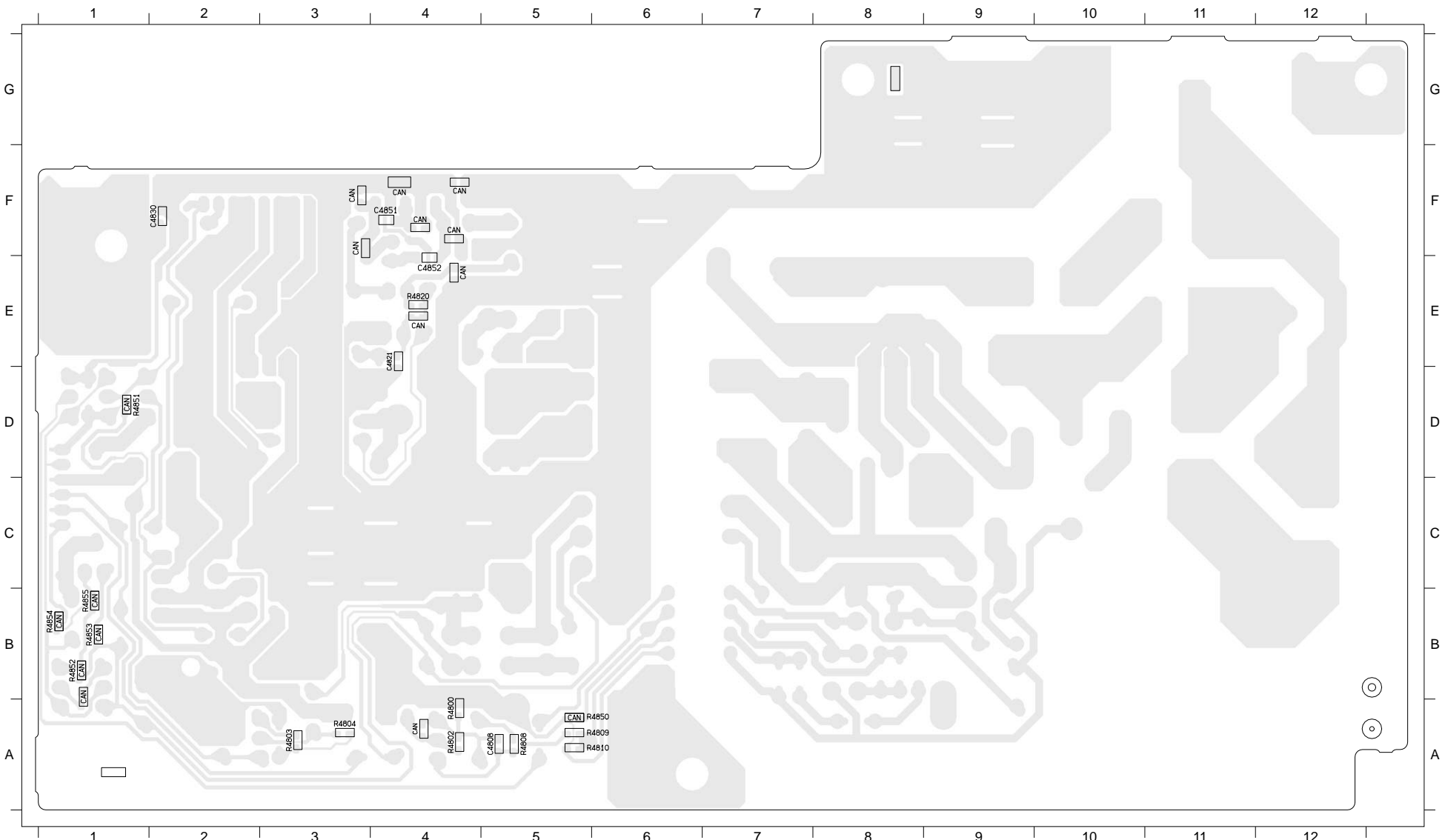

Bedieneinheit / Control Board

Konventionelle Bestückung – Ansicht von der Lötseite / Conventional Assembly – View of the Solder Side

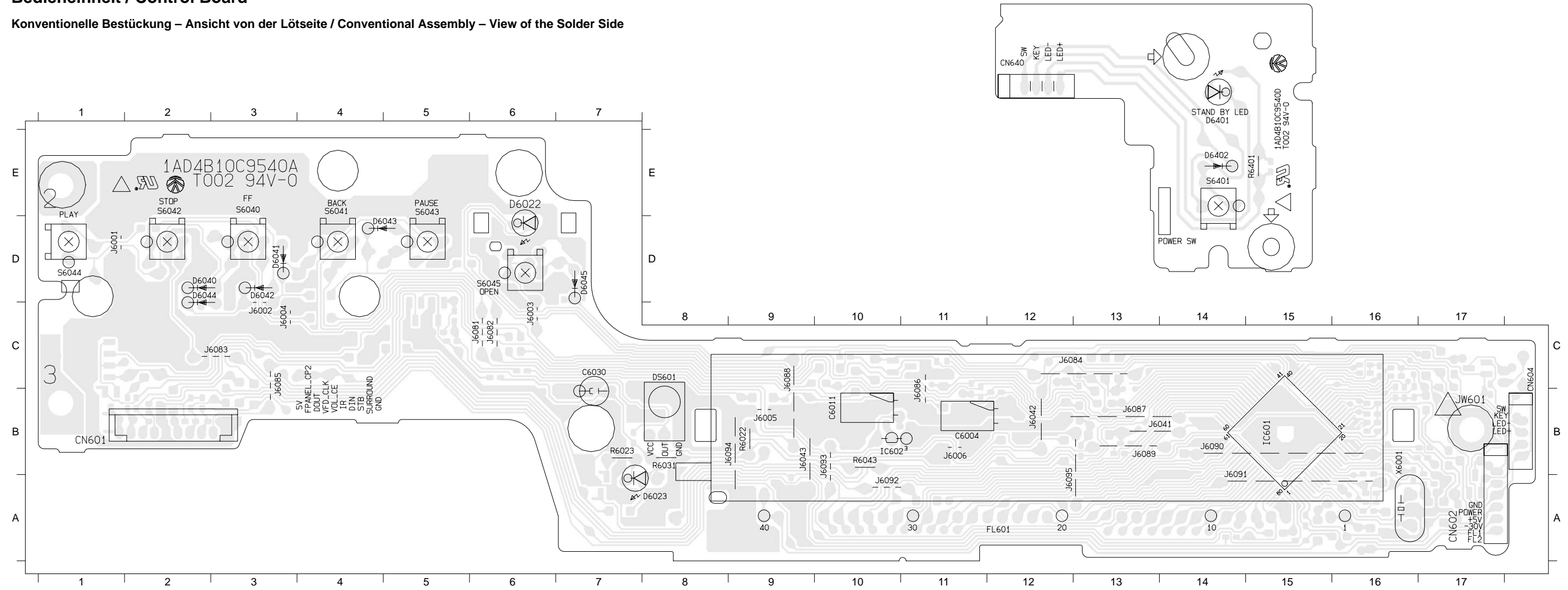

SMD Bestückung – Ansicht von der Lötseite / SMD Assembly – View of the Solder Side

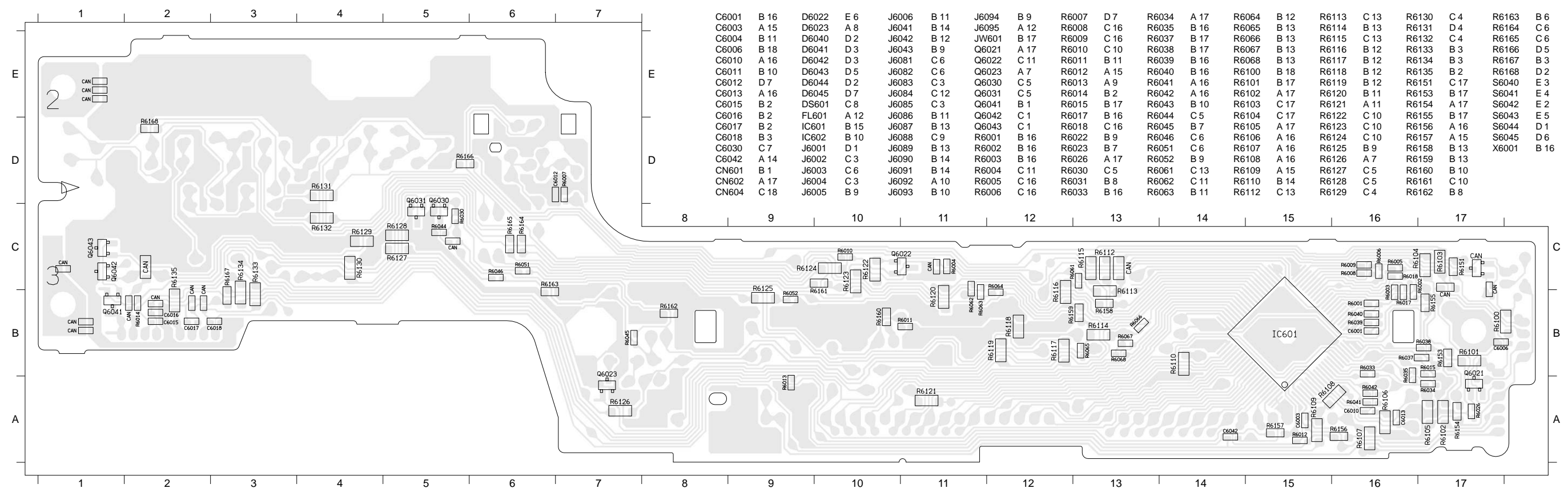

C6001	B 16	D6022	E 6	J6006	B 11	J6094	B 9	R6007	D 7	R6034	A 17	R6064	B 12	R6113	C 13	R6130	C 4	R6163	B 6
C6003	A 15	D6023	A 8	J6041	B 14	J6095	A 12	R6008	C 16	R6035	B 16	R6065	B 13	R6114	B 13	R6131	D 4	R6164	C 6
C6004	B 11	D6040	D 2	J6042	B 12	JW601	B 17	R6009	C 16	R6037	B 17	R6066	B 13	R6115	C 13	R6132	C 4	R6165	C 6
C6006	B 18	D6041	D 3	J6043	B 9	Q6021	A 17	R6010	C 10	R6038	B 17	R6067	B 13	R6116	B 12	R6133	B 3	R6166	D 5
C6010	A 16	D6042	D 3	J6081	C 6	Q6022	C 11	R6011	B 11	R6039	B 16	R6068	B 13	R6117	B 12	R6134	B 3	R6167	B 3
C6011	B 10	D6043	D 5	J6082	C 6	Q6023	A 7	R6012	A 15	R6040	B 16	R6100	B 18	R6118	B 12	R6135	B 2	R6168	D 2
C6012	D 7	D6044	D 2	J6083	C 3	Q6030	C 5	R6013	A 9	R6041	A 16	R6101	B 17	R6119	B 12	R6151	C 17	S6040	E 3
C6013	A 16	D6045	D 7	J6084	C 12	Q6031	C 5	R6014	B 2	R6042	A 16	R6102	A 17	R6120	B 11	R6153	B 17	S6041	E 4
C6015	B 2	DS601	C 8	J6085	C 3	Q6041	B 1	R6015	B 17	R6043	B 10	R6103	C 17	R6121	A 11	R6154	A 17	S6042	E 2
C6016	B 2	FL601	A 12	J6086	B 11	Q6042	C 1	R6017	B 16	R6044	C 5	R6104	C 17	R6122	C 10	R6155	B 17	S6043	E 5
C6017	B 2	IC601	B 15	J6087	B 13	Q6043	C 1	R6018	C 16	R6045	B 7	R6105	A 17	R6123	C 10	R6156	A 16	S6044	D 1
C6018	B 3	IC602	B 10	J6088	C 9	R6001	B 16	R6022	B 9	R6046	C 6	R6106	A 16	R6124	C 10	R6157	A 15	S6045	D 6
C6030	C 7	J6001	D 1	J6089	B 13	R6002	B 16	R6023	B 7	R6051	C 6	R6107	A 16	R6125	B 9	R6158	B 13	X6001	B 16
C6042	A 14	J6002	C 3	J6090	B 14	R6003	B 16	R6026	A 17	R6052	B 9	R6108	A 16	R6126	A 7	R6159	B 13		
CN601	B 1	J6003	C 6	J6091	B 14	R6004	C 11	R6030	C 5	R6061	C 13	R6109	A 15	R6127	C 5	R6160	B 10		
CN602	A 17	J6004	C 3	J6092	A 10	R6005	C 16	R6031	B 8	R6062	C 11	R6110	B 14	R6128	C 5	R6161	C 10		
CN604	C 18	J6005	B 9	J6093	B 10	R6006	C 16	R6033	B 16	R6063	B 11	R6112	C 13	R6129	C 4	R6162	B 8		

Bedieneinheit / Control Board

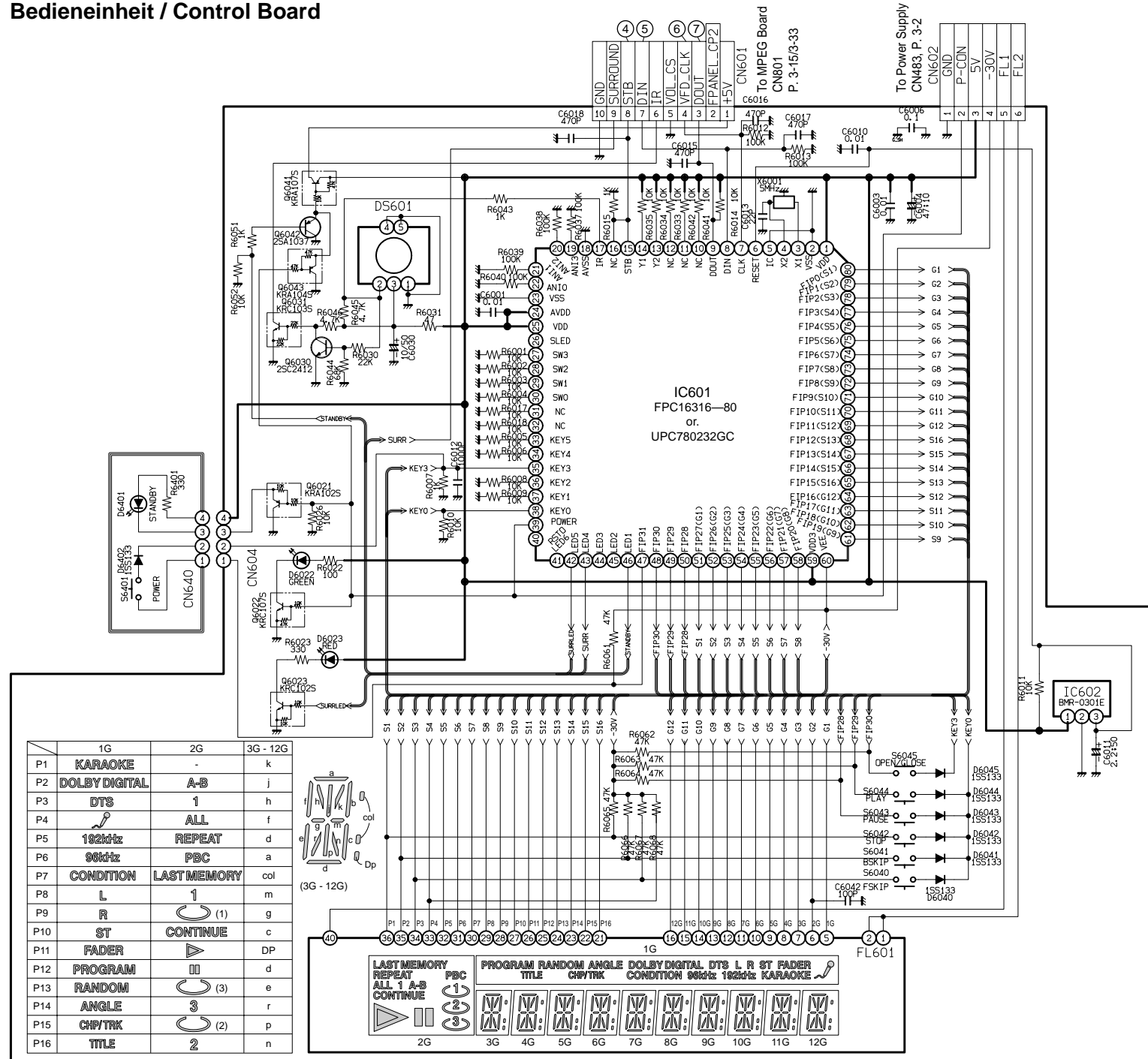

Kopfhörerplatte / Headphone Board

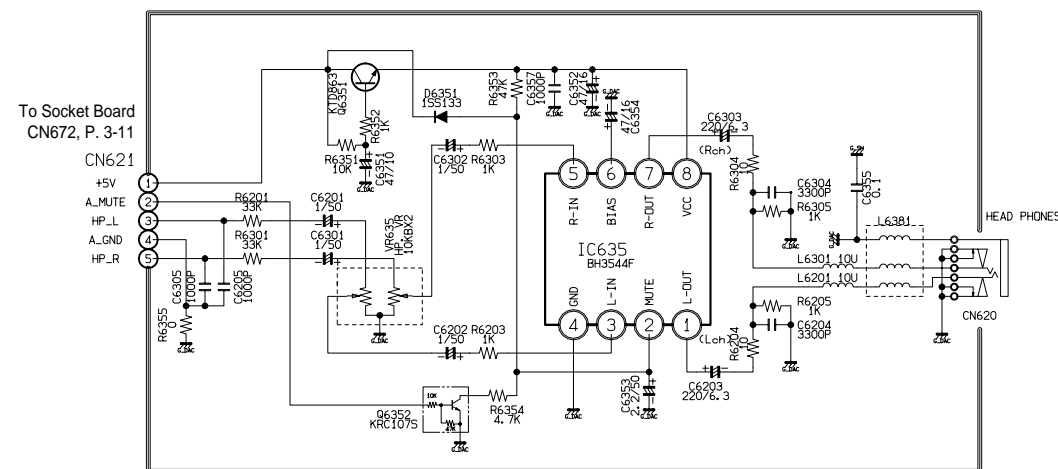

Kopfhörerplatte / Headphone Board

Konventionelle Bestückung – Ansicht von der Lötseite
Conventional Assembly – View of the Solder Side

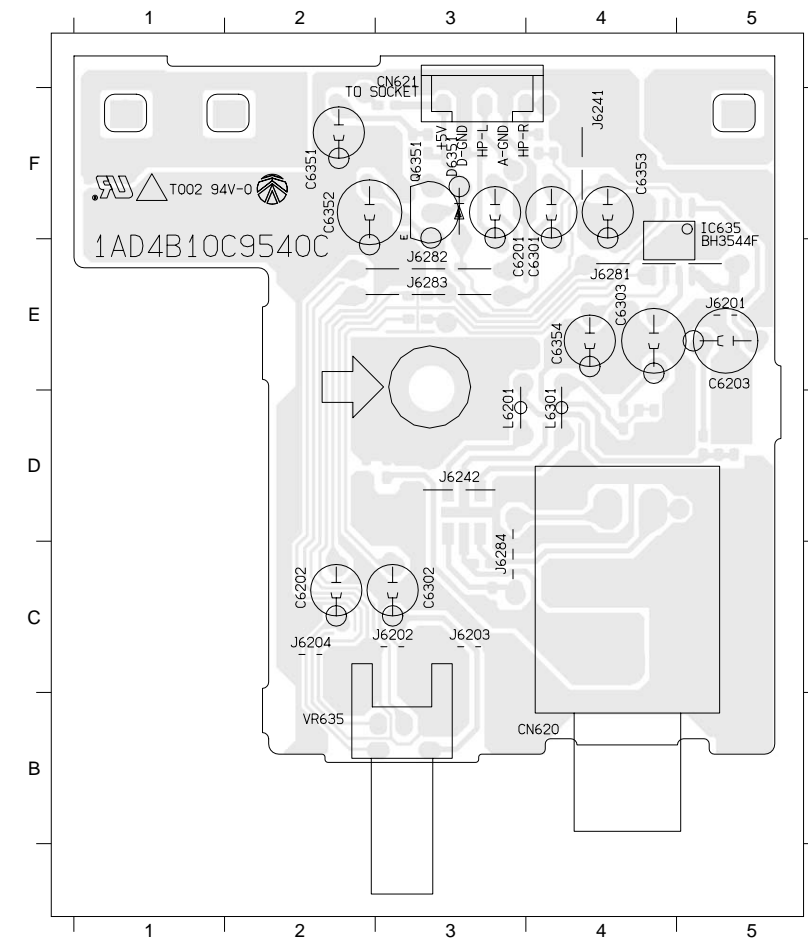

- C6201 E 3
- C6202 C 2
- C6203 D 5
- C6204 D 5
- C6205 F 3
- C6301 E 4
- C6302 C 3
- C6303 E 4
- C6304 D 4
- C6305 F 3
- C6351 F 2
- C6352 F 2
- C6353 F 4
- C6354 E 4
- C6355 D 2
- C6357 F 3
- CN620 B 5
- CN621 F 3
- D6351 F 3
- IC635 E 4
- J6201 E 5
- J6202 C 3
- J6203 C 3
- J6204 C 2
- J6241 F 4
- J6242 D 3
- J6281 E 4
- J6282 E 3
- J6283 E 3
- J6284 C 3
- L6201 D 3
- L6301 D 4
- L6381 D 3
- Q6351 F 3
- Q6352 F 4
- R6201 F 3
- R6203 E 3
- R6204 D 5
- R6205 D 5
- R6301 F 4
- R6303 E 3
- R6304 D 4
- R6305 D 4
- R6351 F 3
- R6352 F 3
- R6353 E 3
- R6354 F 4
- R6355 F 3
- VR635 B 2

SMD Bestückung – Ansicht von der Lötseite
SMD Assembly – View of the Solder Side

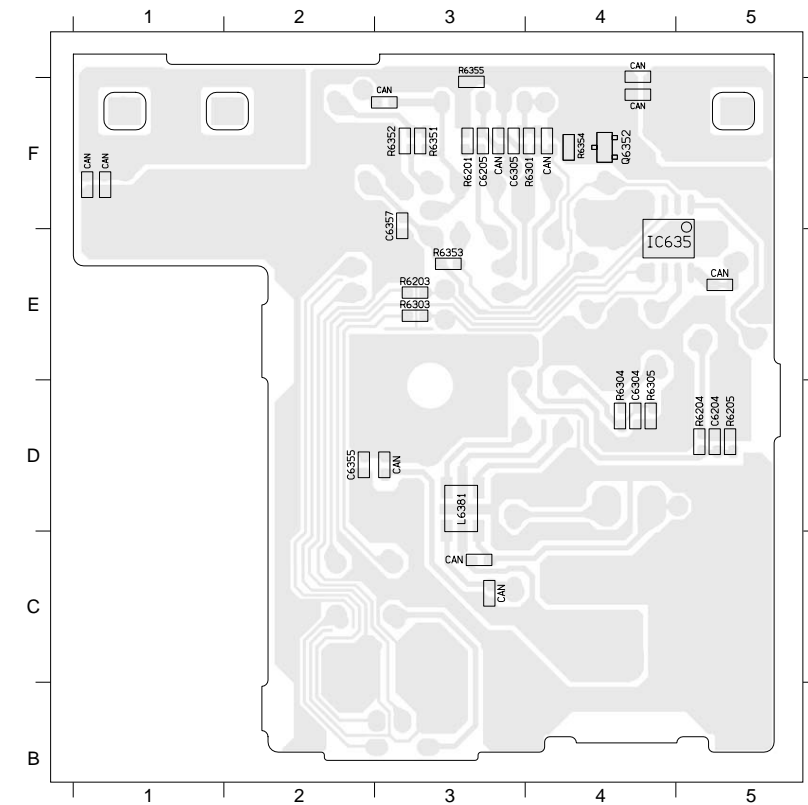

Buchsenplatten / Socket Boards

Konventionelle Bestückung – Ansicht von der Lötseite / Conventional Assembly – View of the Solder Side

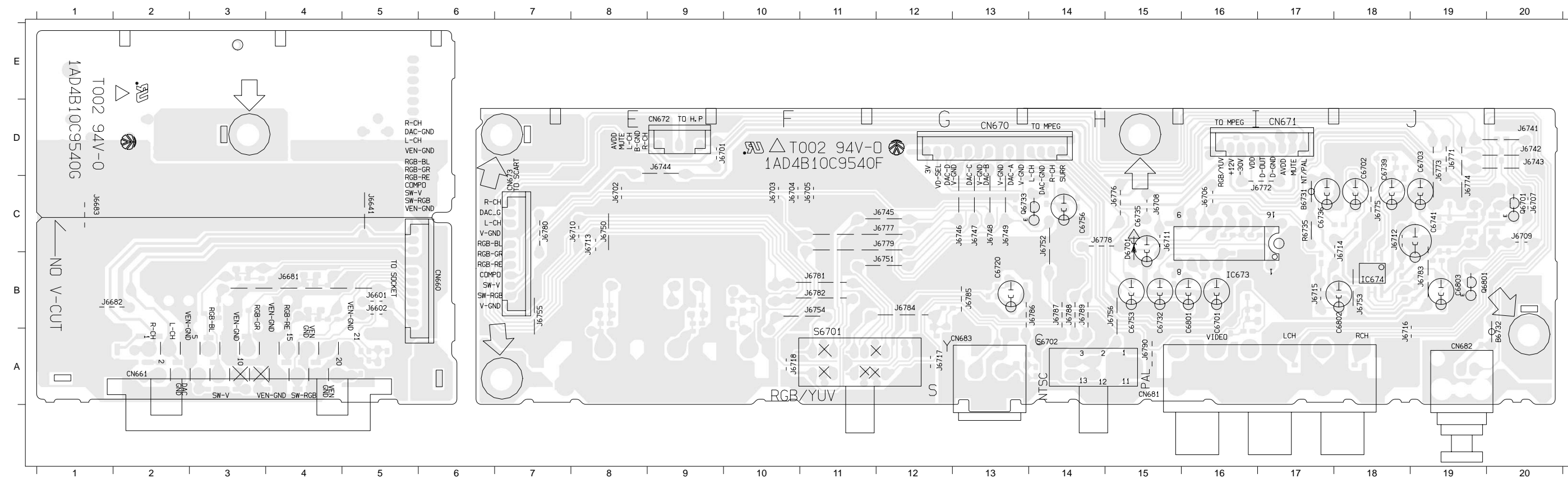

SMD Bestückung – Ansicht von der Lötseite / SMD Assembly – View of the Solder Side

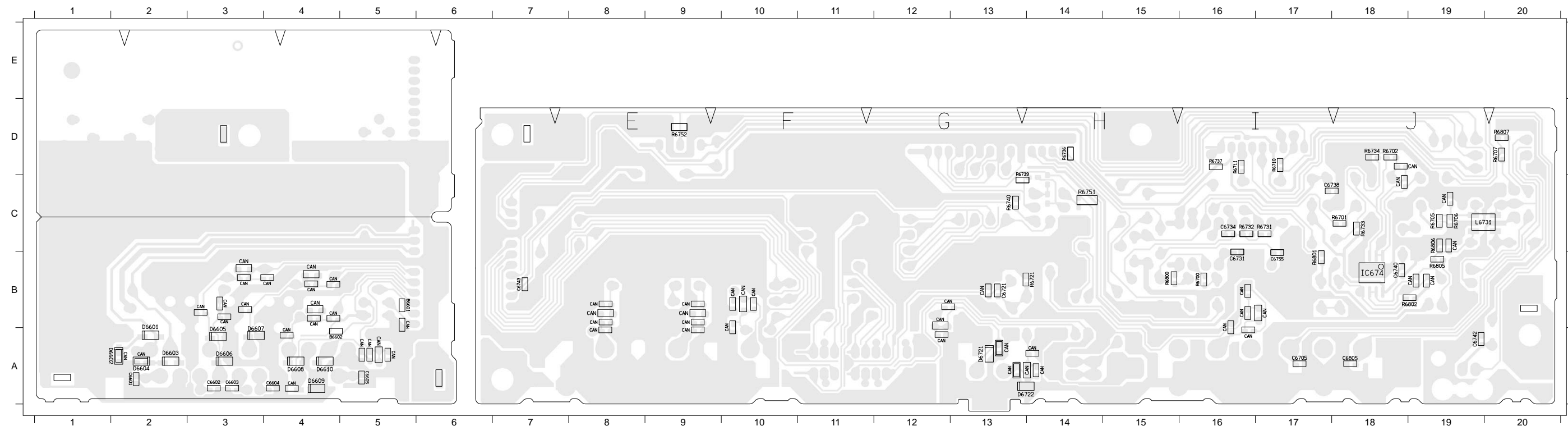

B6601	B 5	C6703	D 19	C6740	B 18	CN660	C 5	D6603	A 2	IC673	B 16	J6704	C 10	J6715	B 17	J6748	C 13	J6773	D 19	J6784	B 12	R6700	B 16	R6733	C 18	R6802	B 19
B6602	A 4	C6705	A 17	C6741	C 19	CN661	A 2	D6604	A 2	IC674	B 18	J6705	C 11	J6716	A 18	J6749	C 13	J6774	C 19	J6785	B 13	R6701	C 18	R6734	D 18	R6805	B 19
B6731	C 17	C6720	B 13	C6742	A 19	CN670	D 13	D6605	A 3	J6601	B 5	J6706	C 16	J6717	A 12	J6750	C 8	J6775	C 18	J6786	B 14	R6702	D 18	R6735	C 17	R6806	C 19
B6732	A 20	C6721	B 13	C6743	B 7	CN671	D 17	D6606	A 3	J6602	B 5	J6707	C 20	J6718	A 10	J6751	B 12	J6776	C 15	J6787	B 14	R6705	C 19	R6736	D 14	R6807	D 20
C6601	A 2	C6731	B 16	C6753	B 15	CN672	D 9	D6607	A 3	J6641	C 5	J6708	C 15	J6741	D 20	J6752	C 14	J6777	C 12	J6788	B 14	R6706	C 19	R6737	D 16	S6701	A 11
C6602	A 3	C6732	B 15	C6755	B 17	CN673	C 7	D6608	A 4	J6681	B 4	J6709	C 20	J6742	D 20	J6753	B 18	J6778	C 14	J6789	B 14	R6707	D 20	R6739	C 13	S6702	A 14
C6603	A 3	C6734	C 16	C6756	C 14	CN681	A 15	D6609	A 4	J6682	B 1	J6710	C 8	J6743	D 20	J6754	B 11	J6779	C 12	J6790	A 15	R6710	D 17	R6740	C 13		
C6604	A 4	C6735	C 15	C6801	B 16	CN682	A 19	D6610	A 4	J6683	C 1	J6711	C 15	J6744	D 9	J6755	B 7	J6780	C 7	L6731	C 19	R6711	D 16	R6751	C 14		
C6605	A 5	C6736	C 17	C6802	B 18	CN683	A 13	D6701	C 15	J6701	D 9	J6712	C 18	J6745	C 12	J6756	B 15	J6781	B 11	Q6701	C 20	R6721	B 13	R6752	D 9		
C6701	B 16	C6738	C 18	C6803	B 19	D6601	A 2	D6721	A 13	J6702	C 8	J6713	C 8	J6746	C 13	J6771	D 19	J6782	B 11	Q6733	C 13	R6731	C 17	R6800	B 15		
C6702	D 18	C6739	D 18	C6805	A 18	D6602	A 2	D6722	A 13	J6703	C 10	J6714	B 18	J6747	C 13	J6772	C 17	J6783	B 19	Q6801	B 19	R6732	C 16	R6801	B 17		

Buchsenplatten / Socket Boards

MPEG-Platte / Board – GDV 120

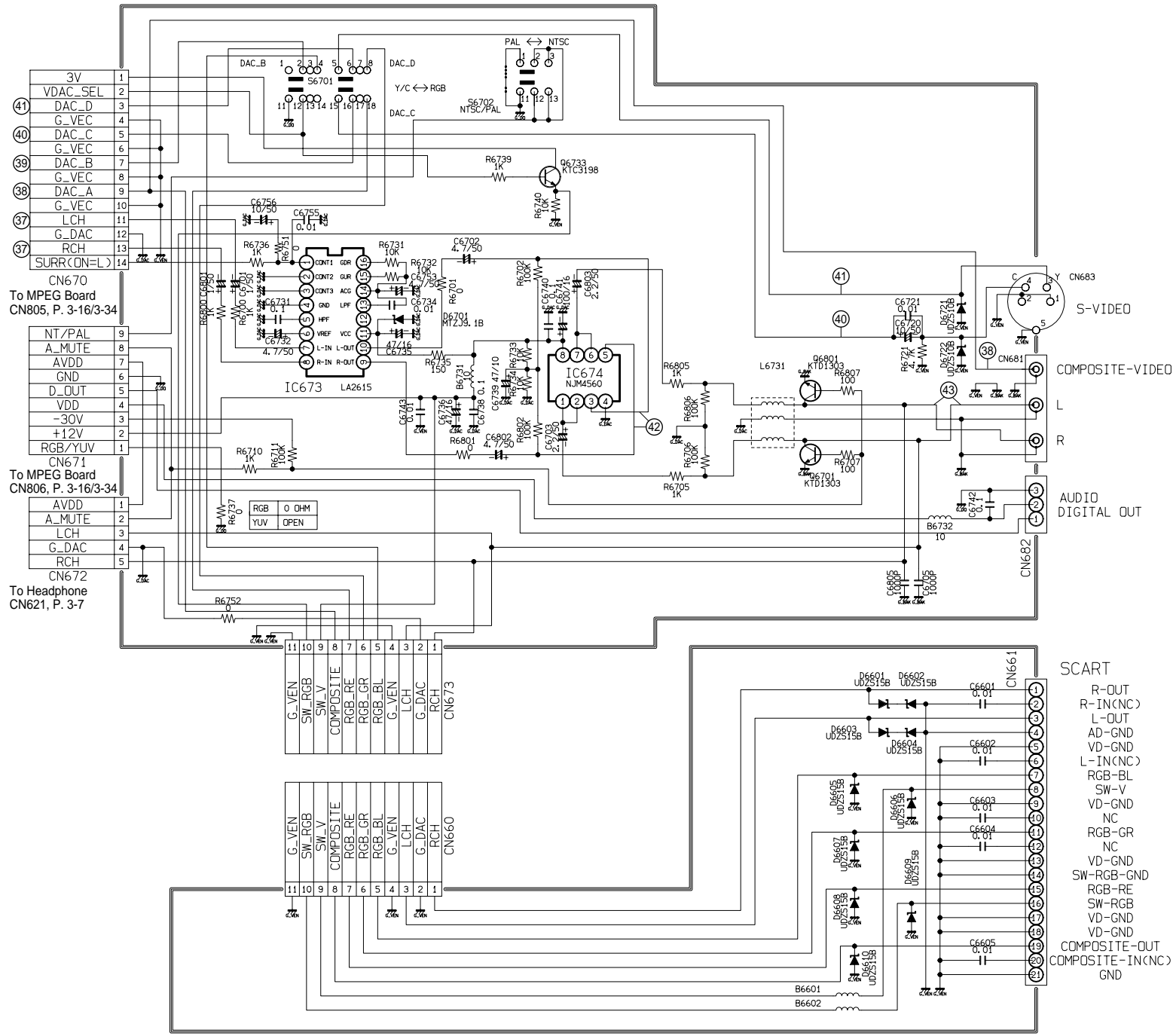

B8012	D 8	C8029	B 3	C8158	B 5	C8503	F 9	R8110	B 11	R8321	C 1	R8507	D 9
B8013	D 10	C8031	E 10	C8159	C 5	C8504	A 9	R8111	B 9	R8322	D 2	R8508	D 9
B8014	D 10	C8032	E 10	C8160	D 5	C8505	B 7	R8112	B 9	R8323	C 2	R8509	D 9
B8015	E 11	C8038	F 10	C8161	E 4	C8506	B 6	R8113	B 10	R8324	C 1	R8510	D 9
B8016	D 10	C8039	F 11	C8162	E 4	C8507	B 6	R8114	B 11	R8325	C 2	R8511	E 9
B8017	D 10	C8040	G 11	C8163	E 4	C8508	E 5	R8115	B 10	R8326	C 2	R8512	E 9
B8018	D 10	C8041	G 4	C8164	E 3	C8903	C 11	R8116	B 11	R8327	C 2	R8513	E 9
B8019	D 11	C8042	F 10	C8165	E 3	C8991	B 8	R8117	B 10	R8328	C 2	R8514	E 9
B8020	F 10	C8043	F 10	C8166	E 2	CL	D 13	R8118	B 10	R8329	C 2	R8515	E 9
B8021	F 10	C8044	F 10	C8167	A 7	CN801	F 1	R8131	D 12	R8330	C 2	R8516	E 9
B8022	C 12	C8045	F 11	C8168	C 6	CN805	A 11	R8132	E 12	R8331	B 1	R8517	E 9
B8023	F 12	C8046	F 6	C8169	E 4	CN806	B 13	R8142	E 13	R8332	B 1	R8518	E 9
B8024	F 12	C8047	E 6	C8171	E 4	CN809	H 5	R8147	A 5	R8333	B 2	R8519	E 9
B8025	F 10	C8048	D 6	C8172	E 3	CN810	H 3	R8148	A 5	R8334	B 2	R8520	E 9
B8026	F 10	C8049	D 6	C8173	E 3	CN818	D 13	R8150	E 1	R8335	B 2	R8521	E 9
B8027	F 10	C8051	A 4	C8181	A 6	IC101	A 4	R8151	E 1	R8336	B 2	R8522	E 9
B8028	F 10	C8052	A 4	C8182	A 6	IC102	B 6	R8152	E 2	R8338	B 2	R8523	E 9
B8029	F 11	C8053	F 12	C8183	A 5	IC103	C 11	R8153	E 2	R8339	B 2	R8524	E 9
B8030	C 3	C8054	F 12	C8184	A 6	IC104	E 12	R8154	F 2	R8340	B 3	R8525	F 9
B8031	C 3	C8055	B 11	C8185	A 6	IC110	D 10	R8155	F 2	R8341	B 3	R8526	F 9
B8032	C 4	C8056	F 9	C8186	A 6	IC111	F 10	R8156	F 2	R8342	B 3	R8527	F 9
B8033	C 4	C8057	C 9	C8187	A 5	IC112	G 3	R8157	F 2	R8343	B 3	R8528	G 8
B8034	D 4	C8058	C 9	C8188	A 6	IC113	G 3	R8158	F 1	R8344	B 3	R8529	G 8
B8035	D 3	C8059	B 6	C8189	A 7	IC116	C 3	R8161	G 2	R8345	B 3	R8530	G 8
B8036	D 3	C8061	D 12	C8190	A 6	IC117	D 3	R8162	G 3	R8346	B 4	R8531	G 8
B8037	C 13	C8063	D 11	C8191	A 5	IC118	F 3	R8163	G 2	R8347	B 4	R8532	G 8
B8040	C 9	C8064	G 8	C8192	A 5	IC127	E 7	R8164	G 3	R8348	B 4	R8533	G 8
B8042	E 6	C8065	F 12	C8210	D 2	IC130	D 1	R8165	G 4	R8349	B 4	R8534	G 8
B8043	B 3	C8066	F 9	C8211	D 1	IC131	A 8	R8166	G 3	R8350	B 4	R8535	G 8
B8048	A 4	C8067	G 9	C8212	C 1	IC132	B 10	R8167	H 3	R8351	B 4	R8536	G 6
B8049	F 9	C8068	E 5	C8213	D 1	IC133	B 7	R8168	H 2	R8352	C 4	R8537	G 6
B8051	D 1	C8069	E 2	C8302	D 10	IC135	C 6	R8169	G 3	R8353	B 4	R8538	G 6
B8052	D 2	C8070	B 11	C8303	D 10	IC136	C 6	R8170	G 6	R8354	B 4	R8539	G 6
B8053	D 2	C8071	D 11	C8304	D 10	IC137	C 9	R8171	G 6	R8355	B 4	R8540	G 6
B8054	B 2	C8073	F 6	C8305	D 11	L8031	A 7	R8172	G 6	R8356	B 4	R8541	G 6
B8055	B 2	C8074	D 2	C8306	E 10	L8032	A 6	R8173	H 6	R8357	C 4	R8542	F 5
B8056	B 3	C8075	F 12	C8307	E 10	L8033	A 5	R8174	H 6	R8358	B 5	R8543	F 5
B8057	B 4	C8076	F 13	C8308	D 10	L8034	A 6	R8175	H 6	R8359	C 5	R8544	F 5
B8058	B 5	C8077	D 2	C8309	F 9	Q8003	A 9	R8176	H 6	R8360	C 5	R8551	C 9
B8059	C 5	C8078	B 2	C8310	F 10	Q8004	A 9	R8177	H 6	R8361	C 5	R8552	C 10
B8060	D 5	C8079	B 2	C8311	F 10	Q8006	B 12	R8178	G 6	R8362	C 5	R8553	C 10
B8061	D 5	C8080	B 3	C8312	F 11	R8001	C 7	R8179	G 6	R8363	C 4	R8554	C 10
B8062	E 4	C8081	B 9	C8313	G 11	R8002	C 6	R8180	H 6	R8364	D 5	R8555	C 10
B8063	E 4	C8082	B 4	C8314	G 10	R8003	C 6	R8181	H 6	R8365	D 5	R8556	C 10
B8064	E 3	C8083	B 4	C8315	F 10	R8004	A 8	R8182	H 6	R8366	D 5	R8557	C 10
B8065	E 3	C8084	C 5	C8316	G 8	R8021	A 8	R8183	G 7	R8381	A 3	R8558	C 10
B8066	E 2	C8085	D 5	C8317	G 6	R8022	A 8	R8201	B 6	R8382	A 3	R8559	E 10
B8075	B 12	C8086	E 5	C8318	C 8	R8023	A 8	R8202	B 6	R8386	A 2	R8560	E 10
B8076	C 13	C8088	B 12	C8321	B 7	R8024	A 8	R8203	B 6	R8387	A 2	R8561	E 10
B8081	B 11	C8089	B 13	C8322	D 9	R8025	A 8	R8204	B 6	R8389	F 3	R8562	E 10
B8351	F 5	C8090	F 3	C8323	D 10	R8026	C 7	R8205	B 6	R8390	G 3	R8563	E 10
B8353	C 4	C8091	B 8	C8324	D 10	R8027	C 7	R8206	B 5	R8391	F 2	R8564	E 10
B8354	G 3	C8092	B 8	C8325	D 11	R8028	C 7	R8207	B 5	R8392	G 3	R8565	E 10
B8355	G 4	C8093	A 9	C8332	A 5	R8029	C 7	R8208	B 5	R8393	G 2	R8566	E 10
B8400	F 8	C8094	A 8	C8337	E 9	R8030	C 7	R8209	A 5	R8394	G 2	R8571	F 10
B8401	F 7	C8095	B 8	C8341	C 4	R8031	C 7	R8210	A 5	R8395	G 2	R8572	F 10
B8402	F 6	C8096	B 12	C8342	C 3	R8032	C 6	R8211	A 5	R8396	G 2	R8573	F 10
B8403	F 6	C8097	C 2	C8343	C 3	R8033	C 6	R8215	A 7	R8397	F 3	R8574	F 10
B8404	E 6	C8098	C 3	C8344	C 2	R8034	C 6	R8216	A 7	R8398	F 3	R8575	F 10
B8405	E 6	C8099	C 3	C8345	D 3	R8035	C 6	R8217	A 7	R8399	F 3	R8576	F 10
B8406	D 6	C8100	C 4	C8346	D 4	R8036	B 7	R8218	A 7	R8400	G 3	R8577	F 10
B8407	C 6	C8101	B 9	C8347	D 4	R8039	C 8	R8219	D 5	R8401	G 3	R8578	F 10
B8408	C 7	C8102	A 9	C8348	B 3	R8040	C 8	R8220	D 5	R8402	G 3	R8579	G 10
B8409	C 8	C8103	B 10	C8351	F 5	R8041	G 4	R8221	D 5	R8405	C 5	R8580	G 10
B8410	D 9	C8104	B 11	C8353	C 5	R8042	D 9	R8222	D 5	R8411	F 7	R8581	G 10
B8411	E 9	C8105	D 4	C8354	G 2	R8043	H 4	R8223	D 5	R8412	G 6	R8582	G 10
B8412	E 9	C8106	D 3	C8355	G 4	R8044	C 8	R8224	C 6	R8413	G 7	R8583	G 10
B8413	F 9	C8107	D 3	C8360	B 6	R8045	H 4	R8225	C 6	R8414	G 7	R8584	G 10
B8414	F 9	C8108	F 8	C8361	B 6	R8046	H 4	R8226	C 6	R8415	G 7	R8585	G 10
C8001	D 12	C8109	E 9	C8362	A 5	R8047	G 4	R8251	A 6	R8416	G 7	R8586	G 9
C8002	C 12	C8110	E 10	C8363	A 6	R8048	C 9	R8252	A 6	R8417	E 6	R8600	B 12
C8003	E 12	C8111	G 2	C8364	A 6	R8051	D 7	R8253	A 5	R8418	E 6	X8001	C 8
C8004	E 12	C8112	G 2	C8374	F 4	R8087	F 12	R8254	A 6	R8419	C 8		
C8005	F 12	C8113	G 4	C8375	A 6	R8089	F 12	R8265	D 1	R8420	B 2		
C8006	E 12	C8121	C 7	C8376	A 6	R8090	C 5	R8301	D 1	R8421	B 3		
C8010	B 8	C8122	C 7	C8379	F 9	R8091	B 11	R8302	D 1	R8431	A 10		
C8011	A 8	C8131	B 10	C8400	F 8	R8092	B 11	R8303	D 1	R8432	B 11		
C8012	B 7	C8132	B 11	C8401	F 7	R8093	B 4	R8304	D 1	R8433	A 10		
C8013	C 6	C8133	B 10	C8402	F 6	R8094	A 4	R8305	D 1	R8434	A 11		
C8014	C 8	C8134	B 10	C8403	F 6	R8096	A 5	R8306	D 1	R8435	A 11		
C8015	D 8	C8135	B 9	C8404	E 5	R8097	A 5	R8307	D 1	R8436	A 11		
C8016	D 8	C8136	A 9	C8405	D 6	R8098	A 4	R8308	D 1	R8437	A 11		
C8017	C 7	C8137	B 10	C8406	D 6	R8099	A 4	R8309	D 1	R8438	B 12		
C8018	C 6	C8138	B 10	C8407	C 7	R8101	B 9	R8310	C 1	R8439	B 12		
C8021	D 9	C8150	E 4	C8408	C 7	R8102	A 8	R8311	C 1	R8440	B 12		
C8022	E 8	C8151	D 1	C8409	C 8	R8103	B 9	R8312	D 2	R8441	A 11		
C8023	F 8	C8152	D 2	C8410	D 9	R8104	A 9	R8313	B 1	R8442	B 12		
C8024	F 8	C8153	D 2	C8411	E 9	R8105	B 9	R8314	C 1	R8501	D 9		
C8025	B 4	C8154	B 2	C8412	E 9	R8106	A 9	R8315	C 1	R8502	D 9		
C8026	E 2	C8155	B 2	C8414	F 9	R8107	B 9	R8316	C 1	R8503	D 9		
C8027	F 7	C8156	B 3	C8501	F 12	R8108	B 10	R8318	C 1	R8504	D 9		
C8028	B 3	C8157	B 4	C8502	F 12	R8109	B 10	R8320	C 1	R8506	D 9		

MPEG-Platte / Board – GDV 120

SMD-Bestückung der Oberseite – Ansicht von der Bestückungsseite / SMD Assembly of the Upper Side – View of the Component Side

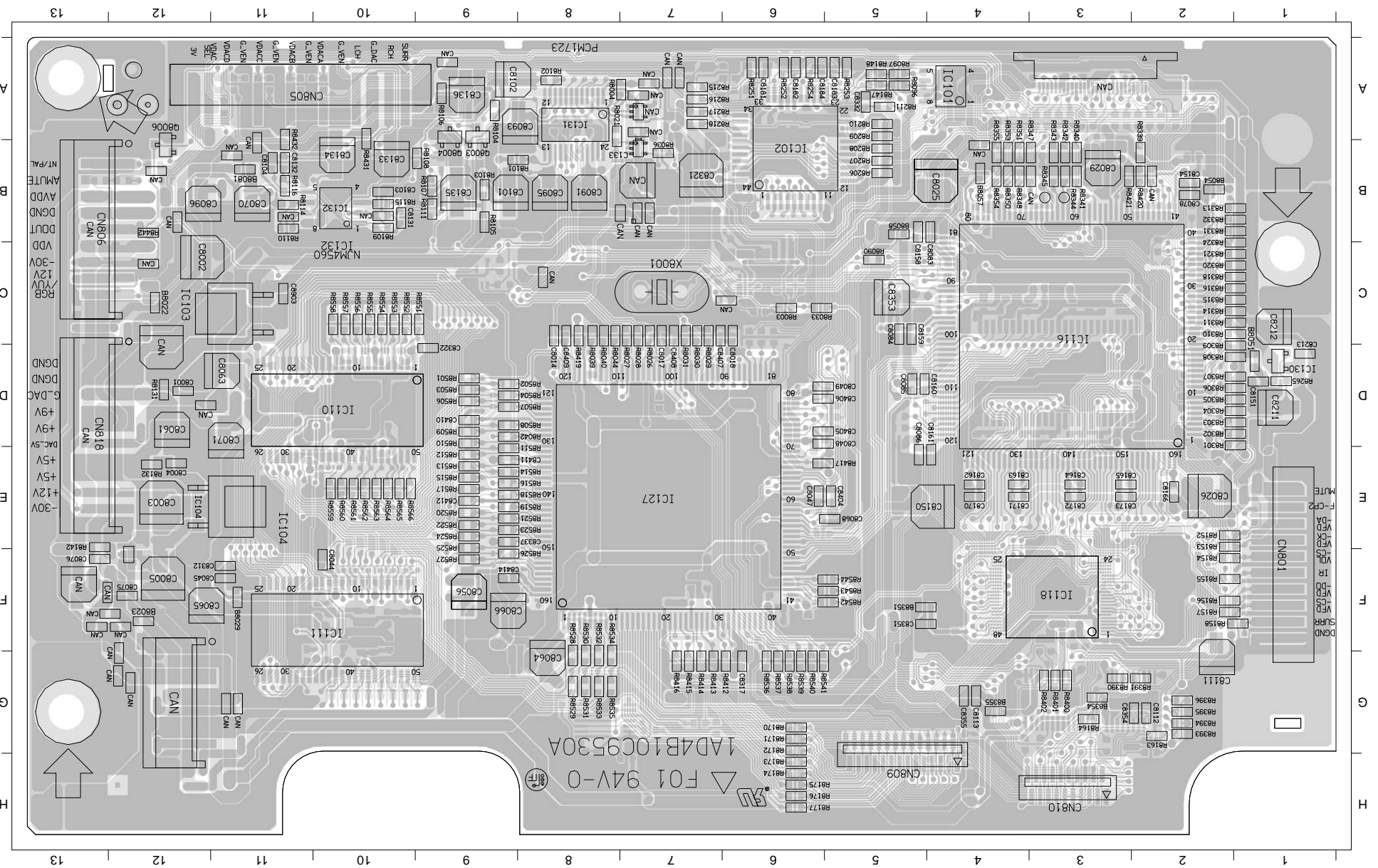

SMD Bestückung der Unterseite – Ansicht von der Lötseite / SMD Assembly of the Lower Side – View of the Solder Side

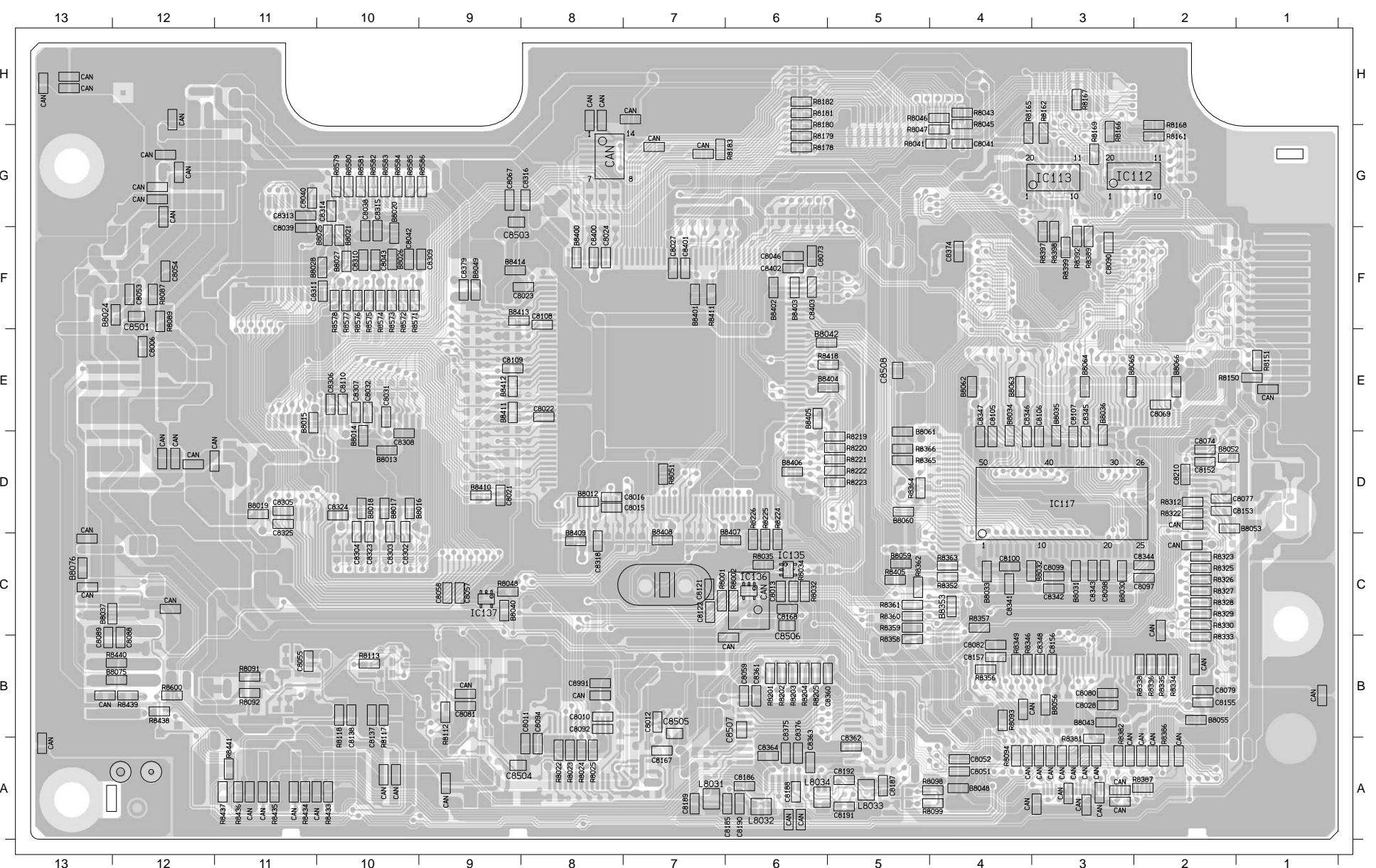

MPEG-Platte / Board – GDV 120

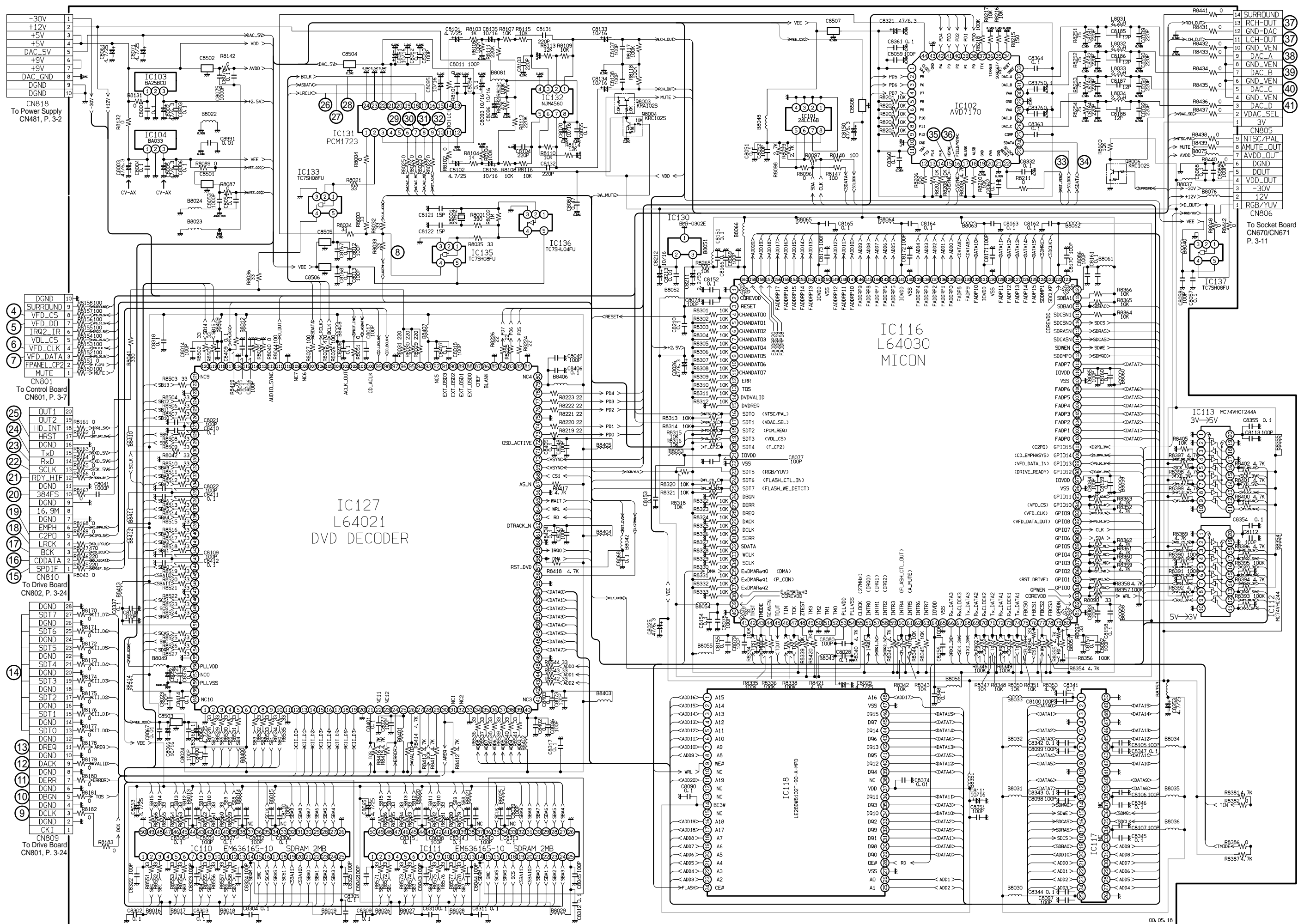

MPEG-Platte / Board – GDV 120 (vergrößert / enlarged)

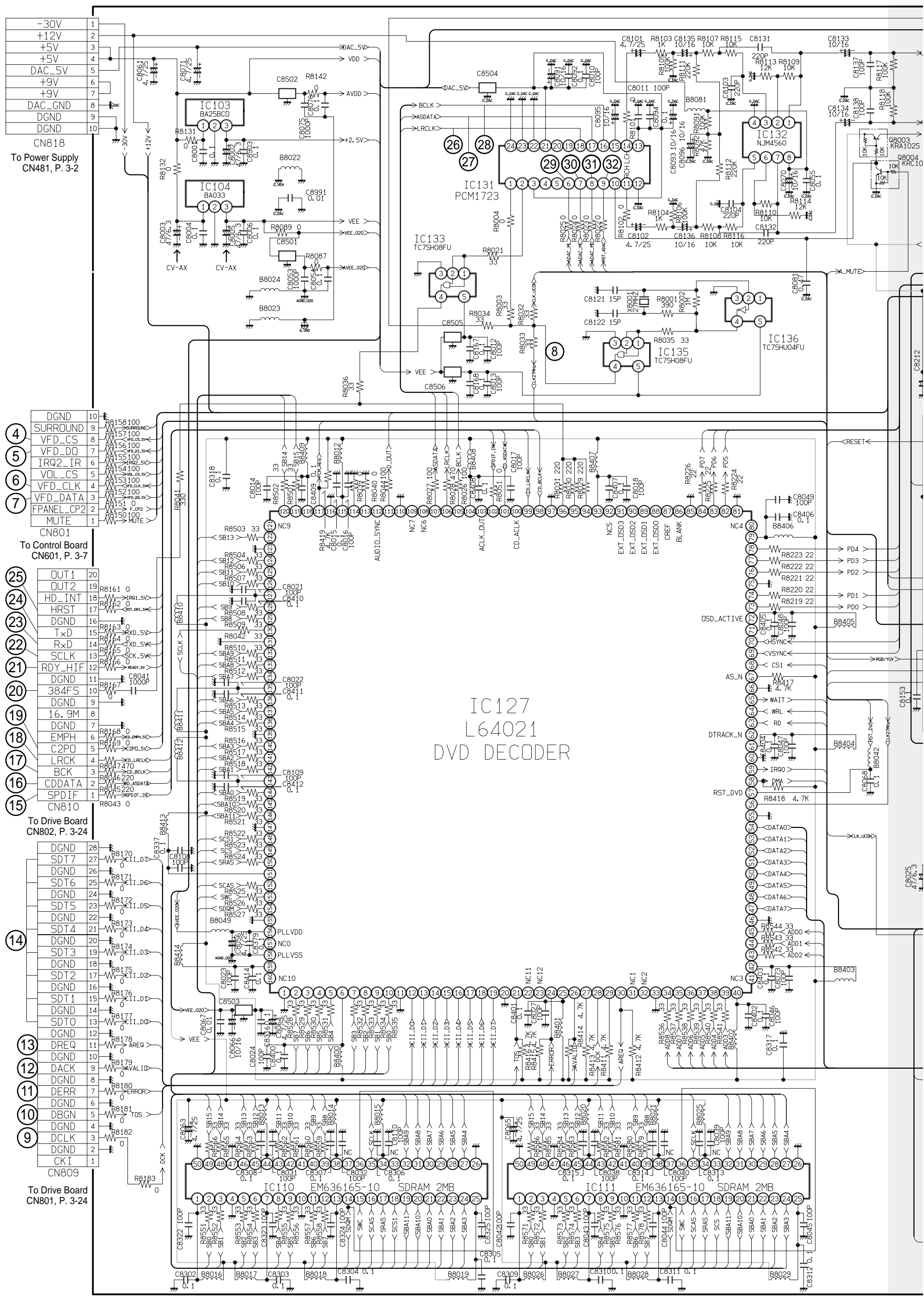

IC127
L64021
DVD DECODER

14	SURROUND	37
13	RCH-OUT	37
12	GND-DAC	38
11	LCH-OUT	39
10	GND_VEN	40
9	DAC_A	41
8	DAC_B	
7	DAC_C	
6	GND_VEN	
5	DAC_D	
4	GND_VEN	
3	DAC_SEL	
2	VDAC_SEL	
1	3V	

9	NTSC/PAL
8	AMUTE_OUT
7	AVDD_OUT
6	DGND
5	DDOUT
4	VDD_OUT
3	-30V
2	12V
1	RGB/YUV

To Socket Board
CN670/CN671
P. 3-11

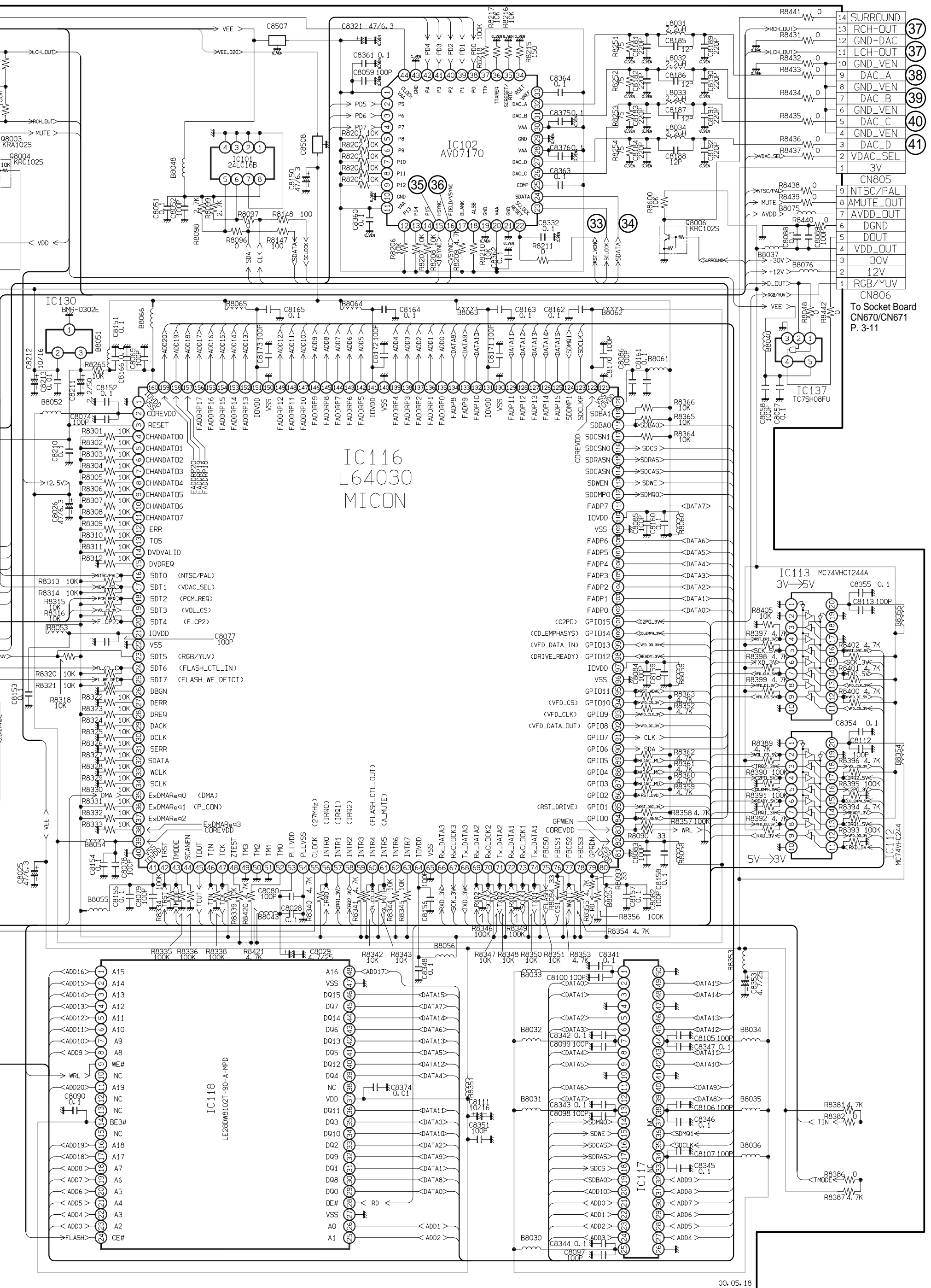

Laufwerkplatte / Drive Board – GDV 120

SMD-Bestückung der Oberseite – Ansicht von der Bestückungsseite / SMD Assembly of the Upper Side – View of the Component Side

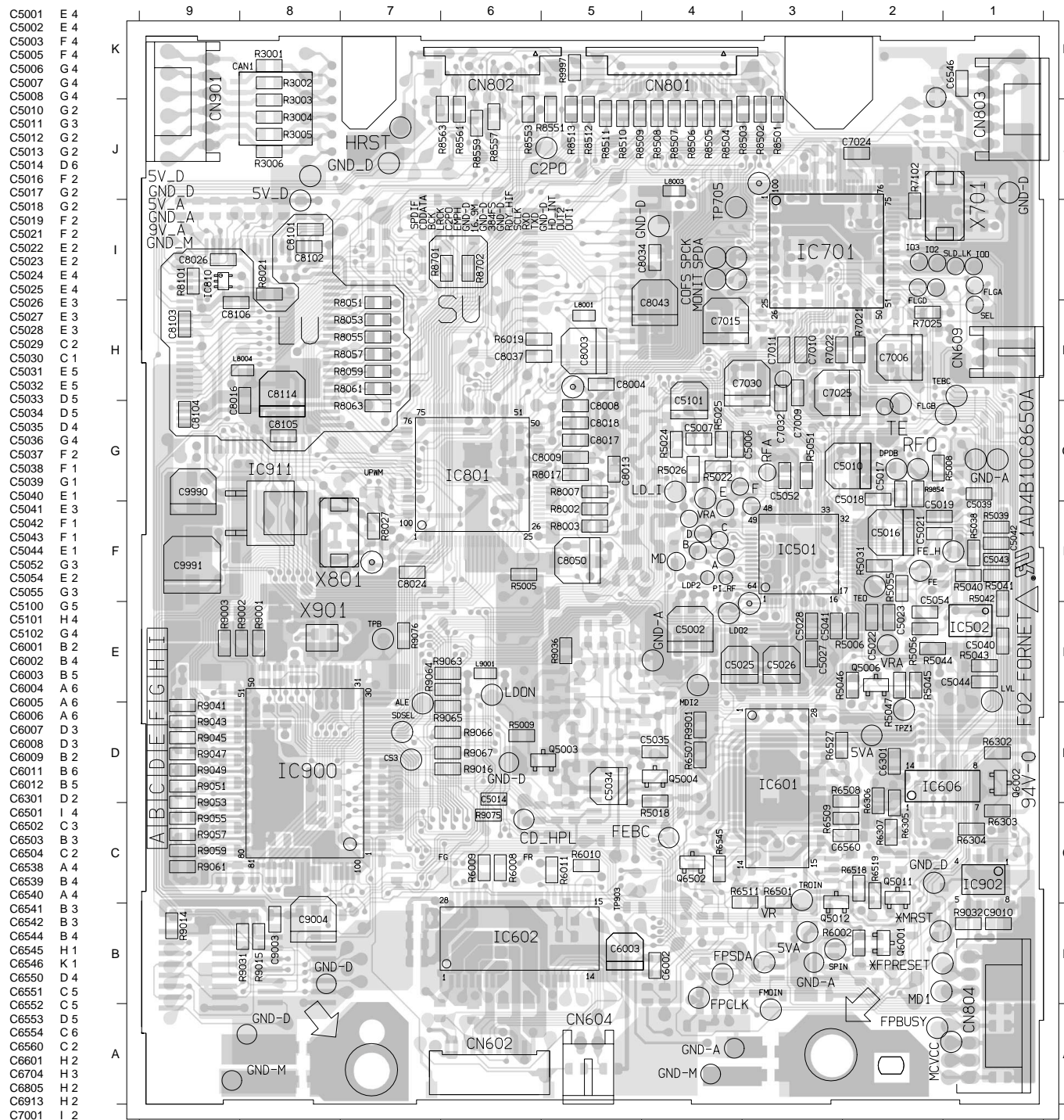

C7007 H3	C8001 F8	C8033 J4	C9012 C8	IC604 C3	L9001 E6	R3006 J8	R5032 D5	R5102 G4	R6305 D2	R6528 C2
C7008 H3	C8002 F8	C8034 I4	C9013 C8	IC605 B2	L9855 E4	R4002 D3	R5037 D2	R5103 H5	R6306 D2	R6529 C2
C7009 H3	C8003 H5	C8035 G6	C9014 B8	IC606 D1	Q5001 G5	R5005 F6	R5038 F1	R5106 H5	R6307 C2	R6530 C2
C7010 H3	C8004 H5	C8037 H6	C9901 C1	IC607 D5	Q5002 G4	R5006 E2	R5039 F1	R6001 B2	R6501 C3	R6533 B4
C7011 H3	C8005 G6	C8041 F5	C9902 E3	IC701 J3	Q5003 D5	R5007 I3	R5040 F1	R6002 B2	R6503 C3	R6534 B4
C7012 H3	C8006 G6	C8042 I4	C9909 G9	IC710 I1	Q5004 D4	R5008 G2	R5041 F1	R6003 B2	R6504 B3	R6535 B4
C7013 I3	C8007 G6	C8043 I4	C9991 F9	IC801 F6	Q5006 E2	R5009 D6	R5042 F1	R6004 B2	R6505 C4	R6536 B4
C7014 H4	C8008 G5	C8050 F5	C9901 E4	IC802 H9	Q5007 E2	R5010 E4	R5043 E1	R6006 B3	R6506 B5	R6537 B4
C7016 H4	C8009 G5	C8051 G6	C9902 A6	IC803 J5	Q5008 E2	R5011 E4	R5044 E2	R6007 B2	R6507 D4	R6538 B4
C7017 I3	C8010 G5	C8101 I8	C9904 A5	IC810 I8	Q5009 G2	R5012 E4	R5045 E2	R6008 C6	R6508 D2	R6539 B4
C7020 J3	C8011 G5	C8102 I8	C9909 I1	IC900 C7	Q5010 G1	R5013 E5	R5046 E2	R6009 C6	R6509 C2	R6540 B3
C7021 J3	C8012 G5	C8103 H9	C9901 J4	IC902 C1	Q5011 C2	R5014 E5	R5047 E2	R6010 C5	R6511 C3	R6541 B3
C7022 J2	C8013 G5	C8104 G9	C9902 J6	IC903 A9	Q5012 C3	R5015 D5	R5049 E2	R6011 C5	R6512 E3	R6542 A4
C7023 I2	C8016 H8	C8105 G8	C9903 J1	IC904 A8	Q6001 B2	R5016 D5	R5050 G3	R6012 B7	R6513 E3	R6543 B3
C7024 J2	C8017 G5	C8106 I9	C9904 B1	IC911 G8	Q6002 D1	R5017 D5	R5051 G3	R6013 B7	R6514 E3	R6544 B4
C7025 H3	C8018 G5	C8114 H8	C9901 J9	L5001 G2	Q6000 B5	R5018 D4	R5052 E2	R6014 B7	R6515 E3	R6545 C4
C7026 H2	C8019 G6	C9001 E7	D5001 H5	L5002 F2	Q6001 C4	R5019 F4	R5053 F2	R6015 B7	R6516 C2	R6546 B4
C7027 I3	C8021 F5	C9002 E8	D8002 K7	L5003 H4	Q6002 C4	R5020 G3	R5056 E2	R6016 A7	R6519 C2	R6550 C4
C7028 H2	C8023 F6	C9003 B8	IC501 E3	L5027 F4	Q7001 H3	R5021 G4	R5057 G2	R6017 A6	R6520 C2	R6551 D4
C7029 I2	C8024 F7	C9004 B8	IC502 D1	L7001 H3	Q9001 C2	R5022 G4	R5058 G2	R6019 H6	R6521 C2	R6552 C4
C7030 H3	C8026 I9	C9006 B8	IC503 F1	L7002 J3	R3001 K8	R5023 G4	R5059 F2	R6101 B2	R6522 C2	R6553 C5
C7031 H3	C8027 G6	C9007 C7	IC507 E6	L8001 H5	R3002 K8	R5024 G4	R5060 F2	R6301 D2	R6524 C2	R6554 C5
C7032 H3	C8030 G6	C9009 B9	IC509 H4	L8002 F5	R3003 K8	R5025 G4	R5061 F1	R6302 D1	R6525 C2	R6555 C5
C7100 I1	C8031 G7	C9010 B1	IC601 D4	L8003 J4	R3004 J8	R5026 G4	R5062 G4	R6303 C1	R6526 C2	R6556 D4
C7101 J2	C8032 G6	C9011 B1	IC602 B7	L8004 H8	R3005 J8	R5027 F2	R5101 G4	R6304 C1	R6527 D3	R6557 C6

SMD Bestückung der Unterseite – Ansicht von der Lötseite / SMD Assembly of the Lower Side – View of the Solder Side

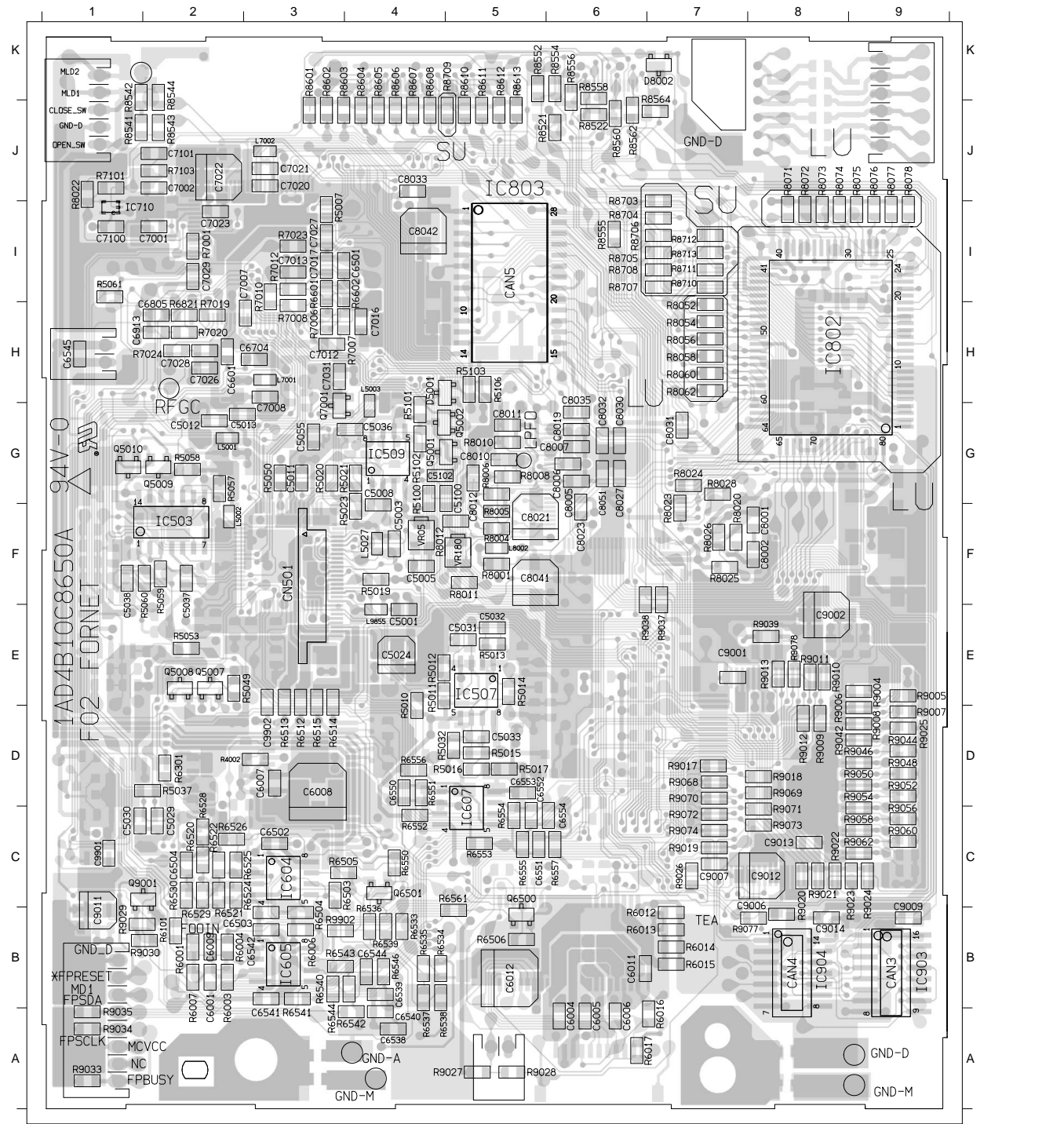

R6561 B5	R8006 G5	R8060 H7	R8513 J5	R8605 J4	R9005 E9	R9030 B2	R9056 C9	R9902 B3	TP601 B3	TP802 F6
R6601 I3	R8007 G5	R8061 H7	R8521 J6	R8606 J4	R9006 E9	R9031 B8	R9057 C9	R9997 K5	TP631 C3	TP803 G5
R6602 I4	R8008 G5	R8062 H7	R8522 J6	R8607 J4	R9007 D9	R9032 B1	R9058 C9	TP501 G3	TP641 B2	TP901 D7
R6821 H2	R8010 G5	R8063 G7	R8541 J1	R8608 J4	R9008 D9	R9033 A1	R9059 C9	TP502 G2	TP651 A3	TP902 D7
R7001 I2	R8011 F5	R8071 I8	R8542 K1	R8610 J5	R9009 D8	R9034 A1	R9060 C9	TP503 G2	TP652 D2	TP903 C4
R7006 H3	R8012 F5	R8072 I8	R8543 J2	R8611 J5	R9010 E8	R9035 A1	R9061 C9	TP504 F3	TP653 C4	TP904 E7
R7007 H4	R8017 G5	R8073 I8	R8544 K2	R8612 J5	R9011 E8	R9036 E5	R9062 C9	TP505 F3	TP691 C6	TP905 E6
R7008 H3	R8020 F7	R8074 I8	R8551 J5	R8613 J5	R9012 D8	R9037 F7	R9063 E6	TP506 G4	TP692 C5	TP906 B7
R7010 I3	R8021 I8	R8075 I9	R8552 K5	R8701 I6	R9013 B8	R9038 F6	R9064 E6	TP507 G4	TP701 I3	TP907 E7
R7012 I3	R8022 J1	R8076 I9	R8553 J6	R8702 I6	R9014 B9	R9039 E8	R9065 D6	TP508 G4	TP702 I4	VR05 F4
R7019 H2	R8023 F7	R8077 I9	R8554 K6	R8703 J7	R9015 B8	R9040 D9	R9066 D6	TP509 G4	TP703 I3	VR180 F5
R7020 H2	R8024 F7	R8078 I9	R8555 I6	R8704 I7	R9016 D6	R9041 D9	R9067 D6	TP510 E4	TP704 I4	XR01 I1
R7021 H2	R8025 F7	R8101 I9	R8556 K6	R8705 I7	R9017 D7	R9042 D9	R9068 D7	TP511 F4	TP705 I3	X801 F7
R7022 H3	R8026 F7	R8501 J3	R8557 J6	R8706 I7	R9018 D8	R9043 D9	R9069 D8	TP512 H2	TP711 I1	X901 E8
R7023 I3	R8027 F7	R8502 J3	R8558 K6	R8707 I7	R9019 C7	R9044 D9	R9070 D7	TP513 F2	TP712 I2	
R7024 H2	R8028 G7	R8503 J4	R8559 J6	R8708 I7	R9020 C8	R9045 D9	R9071 D8	TP514 E3	TP713 I2	
R7025 H2	R8029 G7	R8504 J4	R8560 J6	R8709 J5	R9021 C8	R9046 D9	R9072 C7	TP515 E4	TP714 I1	
R7101 J1	R8052 I7	R8505 J4	R8561 J6	R8710 I7	R9022 C8	R9047 D9	R9073 C8	TP516 E1	TP715 I2	
R7102 I2	R8053 H7	R8506 J4	R8562 J6	R8711 I7	R9023 C9	R9048 D9	R9074 C7	TP517 F2	TP716 G2	
R7103 J2	R8054 H7	R8507 J4	R8563 J6	R8712 I7	R9024 C9	R9049 D9	R9075 C6	TP518 F4	TP717 I2	
R8001 F5	R8055 H7	R8508 J4	R8564 J6	R8713 I7	R9025 D9	R9050 D9	R9076 E7	TP519 F4	TP718 I1	
R8002 F5	R8056 H7	R8509 J5	R8565 J6	R9001 E8	R9026 C7	R9051 D9	R9077 B8	TP520 F1	TP719 I1	
R8003 F5	R8057 H7	R8510 J5	R8566 J6	R9002 E8	R9027 A5	R9052 D9	R9078 E8	TP521 G2	TP721 H1	
R8004 F5	R8058 H7	R8511 J5	R8567 J6	R9003 E9	R9028 A5	R9053 D9	R9079 A5	TP522 C4	TP722 H2	
R8005 F5	R8059 H7	R8512 J5	R8568 J6	R9004 E9	R9029 B2	R9054 D9	R9080 A5	TP523 C1	TP723 H2	

Laufwerkplatte / Drive Board – GDV 120

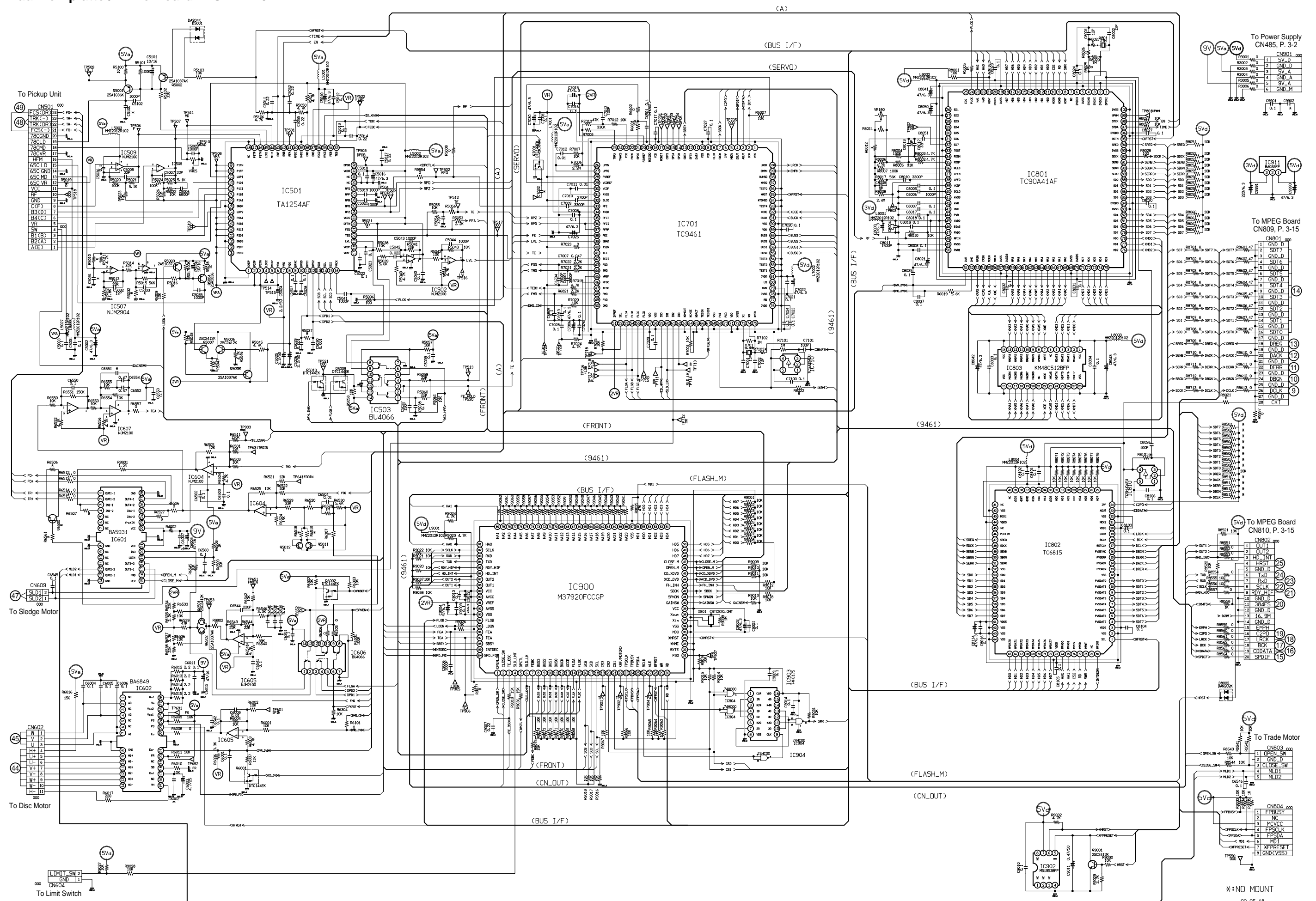

*: NO MOUNT
00.05.18

Laufwerkplatte / Drive Board – GDV 120 (vergrößert / enlarged)

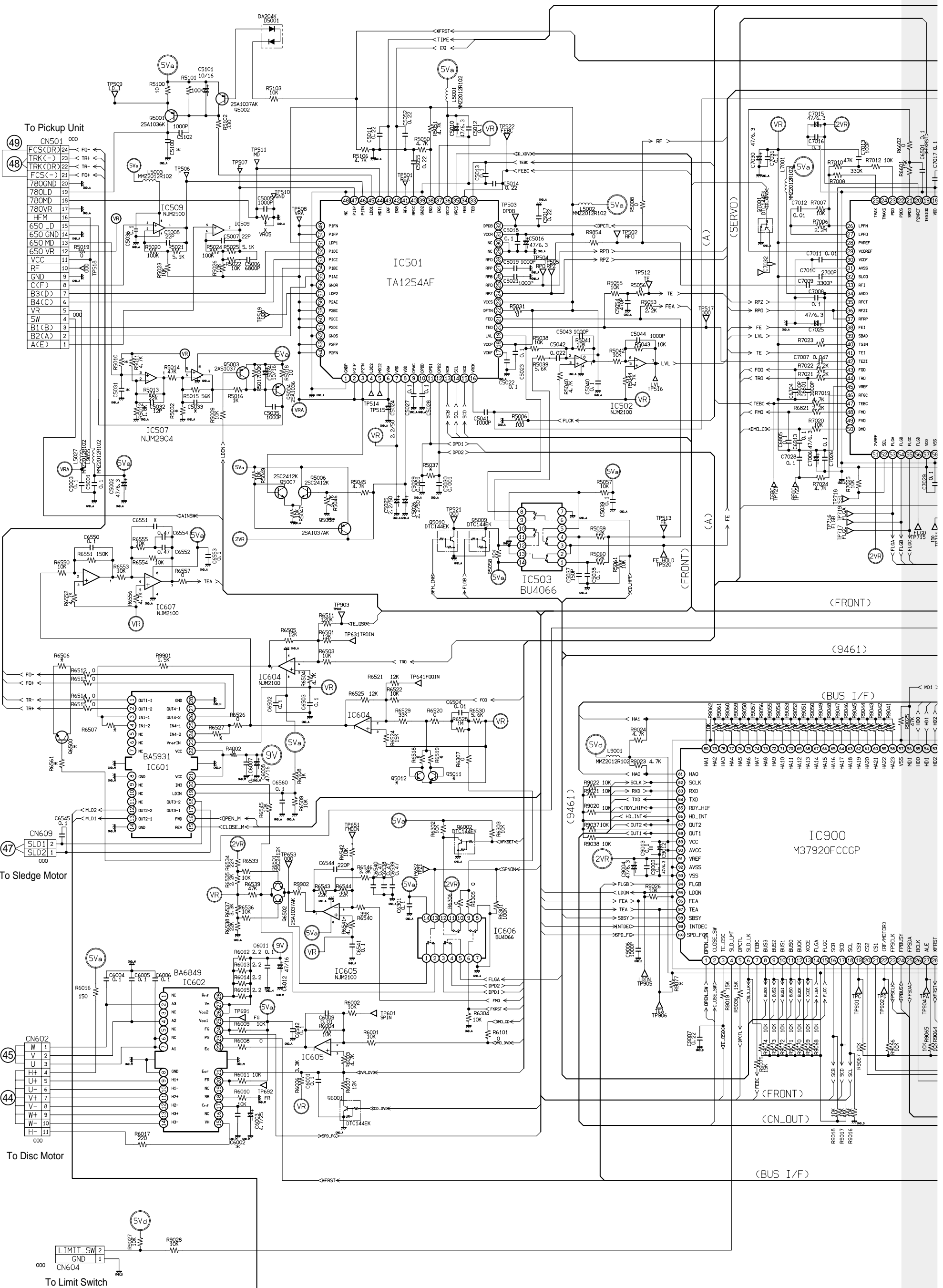

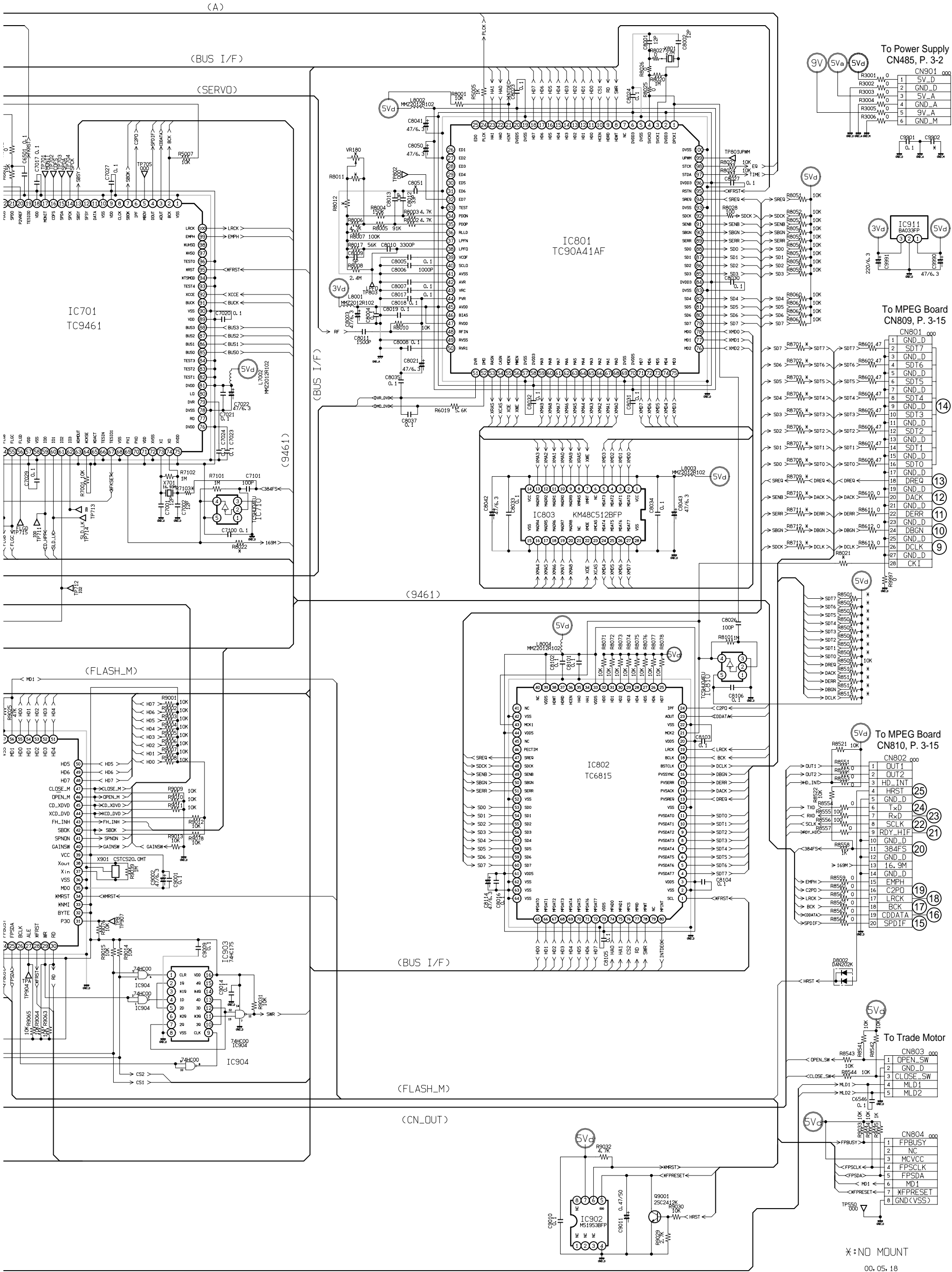

B8012	D 8	C8028	B 3	C8157	B 4	C8414	F 9	R8107	B 9	R8315	C 1	R8502	D 9
B8013	D 10	C8029	B 3	C8158	B 5	C8501	F 12	R8108	B 9	R8316	C 1	R8503	D 9
B8014	D 10	C8031	E 10	C8159	C 5	C8502	F 12	R8109	B 10	R8318	C 1	R8504	D 9
B8015	E 11	C8032	E 10	C8160	D 5	C8503	F 9	R8110	B 11	R8320	C 1	R8506	D 9
B8016	D 10	C8038	F 10	C8161	E 4	C8504	A 9	R8111	B 9	R8321	C 1	R8507	D 9
B8017	D 10	C8039	F 11	C8162	E 4	C8505	B 7	R8112	B 9	R8322	D 2	R8508	D 9
B8018	D 10	C8040	G 11	C8163	E 4	C8506	C 6	R8113	B 10	R8323	C 2	R8509	D 9
B8019	D 11	C8041	G 6	C8164	E 3	C8507	B 6	R8114	B 11	R8324	C 1	R8510	D 9
B8020	F 10	C8042	F 10	C8165	E 3	C8508	E 5	R8115	B 10	R8325	C 2	R8511	E 9
B8021	F 10	C8043	F 10	C8166	E 2	C8903	C 11	R8116	B 11	R8326	C 2	R8512	E 9
B8022	C 12	C8044	F 10	C8167	A 7	C8991	B 8	R8117	B 10	R8327	C 2	R8513	E 9
B8023	F 12	C8045	F 11	C8168	C 6	CN801	F 1	R8118	B 10	R8328	C 2	R8514	E 9
B8024	F 12	C8046	F 6	C8170	E 4	CN805	A 11	R8131	D 12	R8329	C 2	R8515	E 9
B8025	F 10	C8047	E 6	C8171	E 4	CN806	B 13	R8132	E 12	R8330	C 2	R8516	E 9
B8026	F 10	C8048	D 6	C8172	E 3	CN809	H 7	R8142	E 13	R8331	B 1	R8517	E 9
B8027	F 10	C8049	D 6	C8173	E 3	CN810	H 5	R8147	A 5	R8332	B 1	R8518	E 9
B8028	F 10	C8051	A 4	C8175	G 8	CN818	D 13	R8148	A 5	R8333	B 2	R8519	E 9
B8029	F 11	C8052	A 4	C8176	G 8	IC101	A 4	R8150	E 1	R8334	B 2	R8520	E 9
B8030	C 3	C8053	F 12	C8181	A 6	IC102	B 6	R8151	E 1	R8335	B 2	R8521	E 9
B8031	C 3	C8054	F 12	C8182	A 6	IC103	C 11	R8152	E 2	R8336	B 2	R8522	E 9
B8032	C 4	C8055	B 11	C8183	A 5	IC104	E 12	R8153	E 2	R8338	B 2	R8523	E 9
B8033	C 4	C8056	F 9	C8184	A 6	IC105	G 8	R8154	F 2	R8339	B 2	R8524	E 9
B8034	D 4	C8057	C 9	C8185	A 6	IC110	D 10	R8155	F 2	R8340	B 3	R8525	F 9
B8035	D 3	C8058	C 9	C8186	A 6	IC111	F 10	R8156	F 2	R8341	B 3	R8526	F 9
B8036	D 3	C8059	B 6	C8187	A 5	IC112	G 3	R8157	F 2	R8342	B 3	R8527	F 9
B8037	C 13	C8061	D 12	C8188	A 6	IC113	G 3	R8158	F 1	R8343	B 3	R8528	G 8
B8040	C 9	C8063	D 11	C8189	A 7	IC116	C 3	R8161	G 2	R8344	B 3	R8529	G 8
B8042	E 6	C8064	G 9	C8190	A 6	IC117	D 3	R8162	G 3	R8345	B 3	R8530	G 8
B8043	B 3	C8065	F 11	C8191	A 5	IC118	F 3	R8163	G 2	R8346	B 4	R8531	G 8
B8048	A 4	C8066	F 9	C8192	A 5	IC127	E 7	R8164	G 3	R8347	B 3	R8532	G 8
B8049	F 9	C8067	G 9	C8210	D 2	IC130	D 1	R8165	G 4	R8348	B 4	R8533	G 8
B8051	D 1	C8068	E 5	C8211	D 1	IC131	A 8	R8166	G 3	R8349	B 4	R8534	G 8
B8052	D 2	C8069	E 2	C8212	C 1	IC132	B 10	R8167	G 6	R8350	B 4	R8535	G 8
B8053	D 2	C8070	B 11	C8213	D 1	IC133	B 7	R8168	H 2	R8351	B 4	R8536	G 6
B8054	B 2	C8071	D 11	C8302	D 10	IC135	C 6	R8169	G 3	R8352	C 4	R8537	G 6
B8055	B 2	C8073	F 6	C8303	D 10	IC136	C 6	R8170	G 7	R8353	B 4	R8538	G 6
B8056	B 3	C8074	D 2	C8304	D 10	IC137	C 9	R8171	G 7	R8354	B 4	R8539	G 6
B8057	B 4	C8075	F 12	C8305	D 11	L8031	A 7	R8172	G 7	R8355	B 4	R8540	G 6
B8058	B 5	C8076	F 13	C8306	E 10	L8032	A 6	R8173	G 7	R8356	B 4	R8541	G 6
B8059	C 5	C8077	D 2	C8307	E 10	L8033	A 5	R8174	G 7	R8357	C 4	R8542	F 5
B8060	D 5	C8078	B 2	C8308	D 10	L8034	A 6	R8175	G 8	R8358	B 5	R8543	F 5
B8061	D 5	C8079	B 2	C8309	F 10	Q8003	A 9	R8176	G 8	R8359	C 5	R8544	F 5
B8062	E 4	C8080	B 3	C8310	F 10	Q8004	A 9	R8177	G 8	R8360	C 5	R8551	C 9
B8063	E 4	C8081	B 9	C8311	F 10	Q8006	B 12	R8178	G 6	R8361	C 5	R8552	C 10
B8064	E 3	C8082	B 4	C8312	F 11	R8001	C 7	R8179	G 6	R8362	C 5	R8553	C 10
B8065	E 3	C8083	B 4	C8313	G 11	R8002	C 6	R8180	G 6	R8363	C 4	R8554	C 10
B8066	E 2	C8084	C 5	C8314	G 10	R8003	C 6	R8181	G 6	R8364	D 5	R8555	C 10
B8069	G 8	C8085	D 5	C8315	F 10	R8004	A 7	R8182	G 7	R8365	D 5	R8556	C 10
B8075	B 12	C8086	E 5	C8316	G 9	R8021	A 8	R8183	G 7	R8366	D 5	R8557	C 10
B8076	C 13	C8088	B 12	C8317	F 6	R8022	A 8	R8184	G 7	R8381	A 3	R8558	C 10
B8081	B 11	C8089	B 13	C8318	C 8	R8023	A 8	R8201	B 6	R8382	A 3	R8559	E 10
B8351	F 5	C8090	F 3	C8321	B 7	R8024	A 8	R8202	B 6	R8386	A 2	R8560	E 10
B8353	C 4	C8091	B 8	C8322	D 9	R8025	A 8	R8203	B 6	R8387	A 2	R8561	E 10
B8354	G 3	C8092	B 8	C8323	D 10	R8026	C 7	R8204	B 6	R8389	F 3	R8562	E 10
B8355	G 4	C8093	A 8	C8324	D 10	R8027	C 7	R8205	B 6	R8390	G 3	R8563	E 10
B8400	F 8	C8094	A 8	C8325	D 11	R8028	C 7	R8206	B 5	R8391	G 2	R8564	E 10
B8401	F 7	C8095	B 8	C8332	A 5	R8029	C 7	R8207	B 5	R8392	F 3	R8565	E 10
B8402	F 6	C8096	B 12	C8337	E 9	R8030	C 7	R8208	B 5	R8393	G 2	R8566	E 10
B8403	F 6	C8097	C 2	C8341	C 4	R8031	C 7	R8209	A 5	R8394	G 2	R8571	F 10
B8404	E 5	C8098	C 3	C8342	C 3	R8032	C 6	R8210	A 5	R8395	G 2	R8572	F 10
B8405	E 6	C8099	C 3	C8343	C 3	R8033	C 6	R8211	A 5	R8396	G 2	R8573	F 10
B8406	D 6	C8100	C 4	C8344	C 2	R8034	C 6	R8215	A 7	R8397	F 3	R8574	F 10
B8407	C 6	C8101	B 9	C8345	D 3	R8035	C 6	R8216	A 7	R8398	F 3	R8575	F 10
B8408	C 7	C8102	A 9	C8346	D 4	R8036	B 7	R8217	A 7	R8399	F 3	R8576	F 10
B8409	C 8	C8103	B 10	C8347	D 4	R8039	C 8	R8218	A 7	R8400	G 3	R8577	F 10
B8410	D 9	C8104	B 11	C8348	B 3	R8040	C 8	R8219	D 5	R8401	G 3	R8578	F 10
B8411	E 9	C8105	D 4	C8351	F 5	R8041	G 6	R8220	D 5	R8402	G 3	R8579	G 10
B8412	E 9	C8106	D 3	C8353	C 5	R8042	D 9	R8221	D 5	R8405	C 5	R8580	G 10
B8413	F 9	C8107	D 3	C8354	G 2	R8043	H 6	R8222	D 5	R8411	F 7	R8581	G 10
B8414	F 8	C8108	F 8	C8355	G 4	R8044	C 8	R8223	D 5	R8412	F 7	R8582	G 10
C8001	D 12	C8109	E 9	C8360	B 6	R8045	G 6	R8224	C 6	R8413	F 7	R8583	G 10
C8002	C 12	C8110	E 10	C8361	B 6	R8046	G 6	R8225	C 6	R8414	F 7	R8584	G 10
C8003	E 12	C8111	G 2	C8362	A 5	R8047	G 6	R8226	C 6	R8415	F 7	R8585	G 10
C8004	E 12	C8112	G 2	C8363	A 6	R8048	C 9	R8251	A 6	R8416	F 7	R8586	G 9
C8005	F 12	C8113	G 4	C8364	A 6	R8051	D 7	R8252	A 6	R8417	E 6	R8600	B 12
C8006	E 12	C8121	C 7	C8374	F 4	R8087	F 12	R8253	A 5	R8418	E 5	X8001	C 8
C8010	B 8	C8122	C 7	C8375	A 6	R8089	F 12	R8254	A 6	R8419	C 8		
C8011	A 8	C8131	B 10	C8376	A 6	R8090	C 5	R8265	D 1	R8420	B 2		
C8012	B 7	C8132	B 11	C8379	F 9	R8091	B 11	R8301	D 1	R8421	B 3		
C8013	C 6	C8133	B 10	C8400	F 8	R8092	B 11	R8302	D 1	R8431	A 10		
C8014	C 8	C8134	B 10	C8401	F 7	R8093	B 4	R8303	D 1	R8432	B 11		
C8015	D 8	C8135	B 9	C8402	F 6	R8094	A 4	R8304	D 1	R8433	A 10		
C8016	D 8	C8136	A 9	C8403	F 6	R8096	A 5	R8305	D 1	R8434	A 11		
C8017	C 7	C8137	B 10	C8404	E 5	R8097	A 5	R8306	D 1	R8435	A 11		
C8018	C 6	C8138	B 10	C8405	D 6	R8098	A 4	R8307	D 1	R8436	A 11		
C8021	D 9	C8150	E 4	C8406	D 6	R8099	A 4	R8308	D 1	R8437	A 11		
C8022	E 8	C8151	D 1	C8407	C 7	R8101	B 9	R8309	D 1	R8438	B 12		
C8023	F 8	C8152	D 2	C8408	C 7	R8102	A 8	R8310	C 1	R8439	B 12		
C8024	F 8	C8153	D 2	C8409	C 8	R8103	B 9	R8311	C 1	R8440	B 12		
C8025	B 4	C8154	B 2	C8410	D 9	R8104	A 9	R8312	D 2	R8441	A 11		
C8026	E 2	C8155	B 2	C8411	E 9	R8105	B 9	R8313	B 1	R8442	B 12		
C8027	F 7	C8156	B 3	C8412	E 9	R8106	A 9	R8314	C 1	R8501	D 9		

MPEG-Platte / Board – GDV 120/02

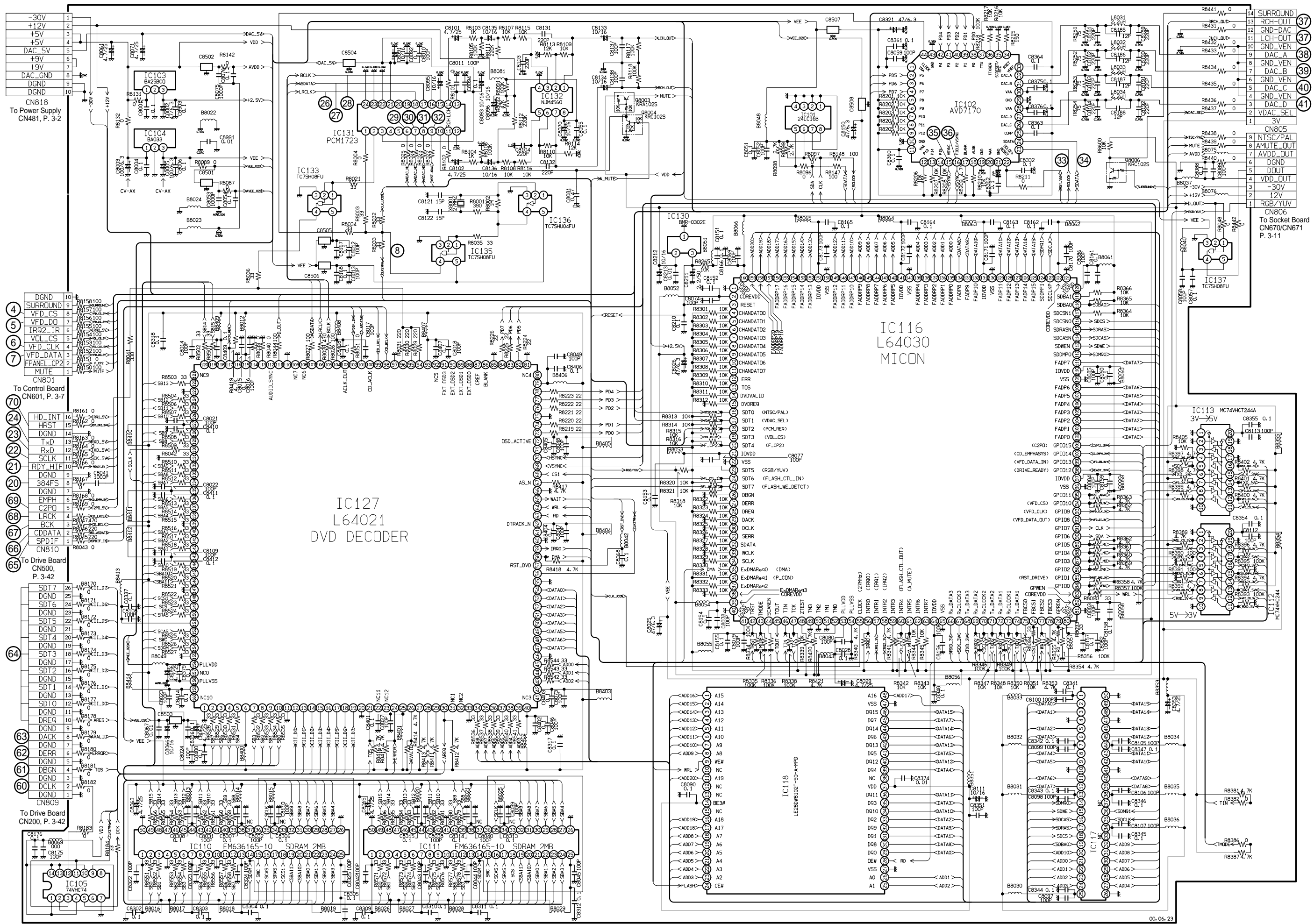

MPEG-Platte / Board - GDV 120/02 (vergrößert / enlarged)

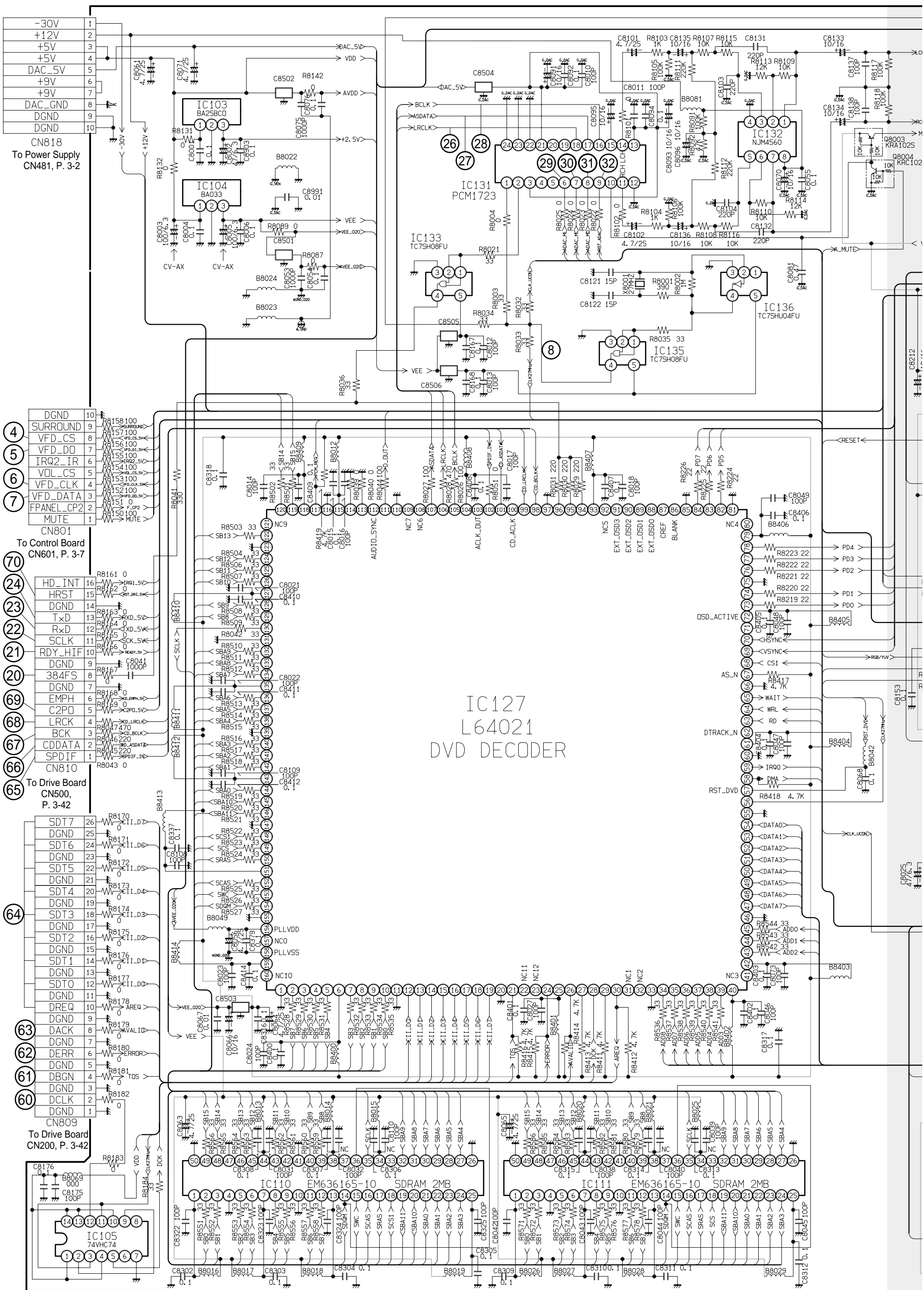

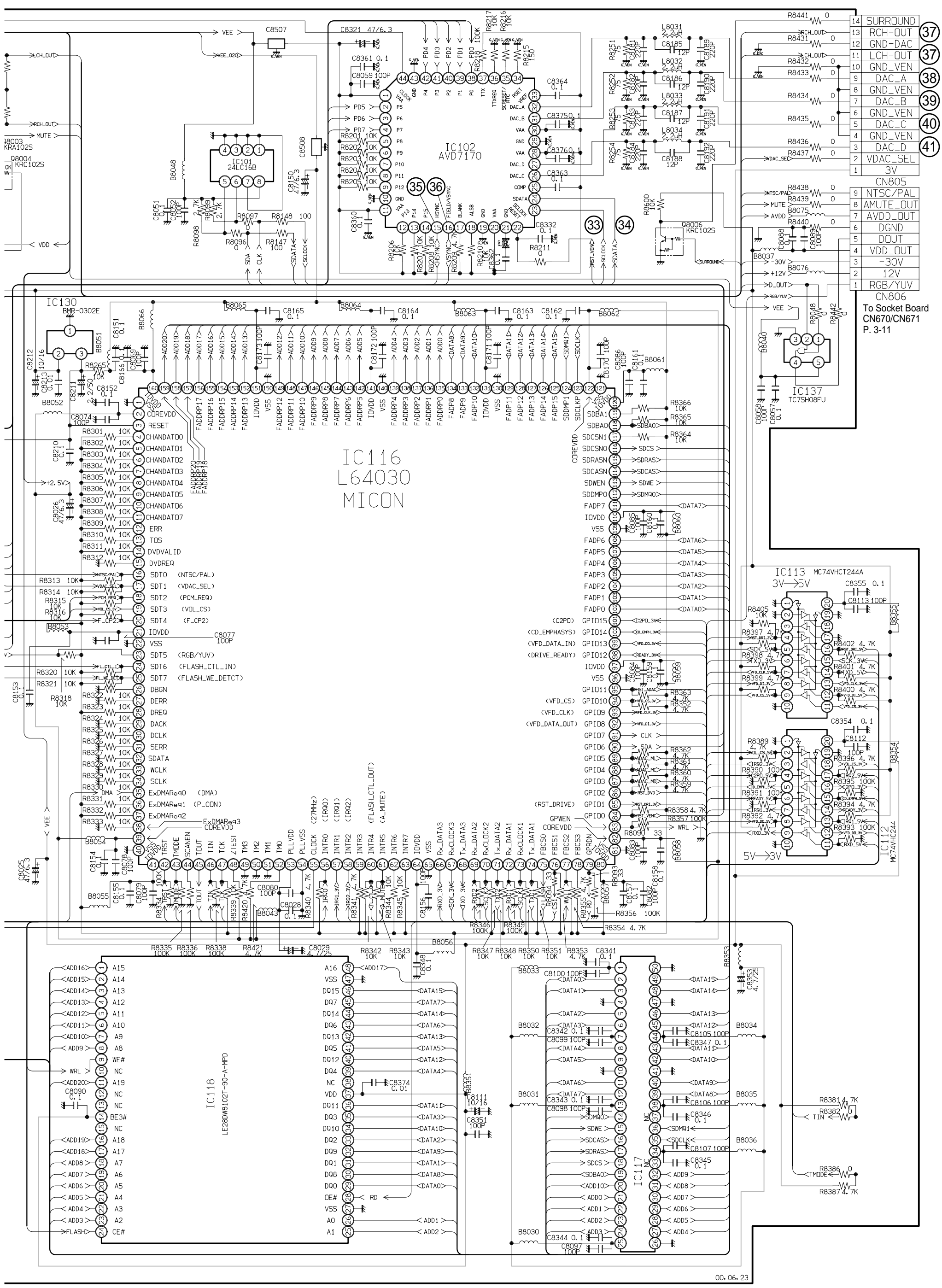

Laufwerkplatte / Drive Board – GDV 120/02

SMD-Bestückung der Oberseite – Ansicht von der Bestückungsseite / SMD Assembly of the Upper Side – View of the Component Side

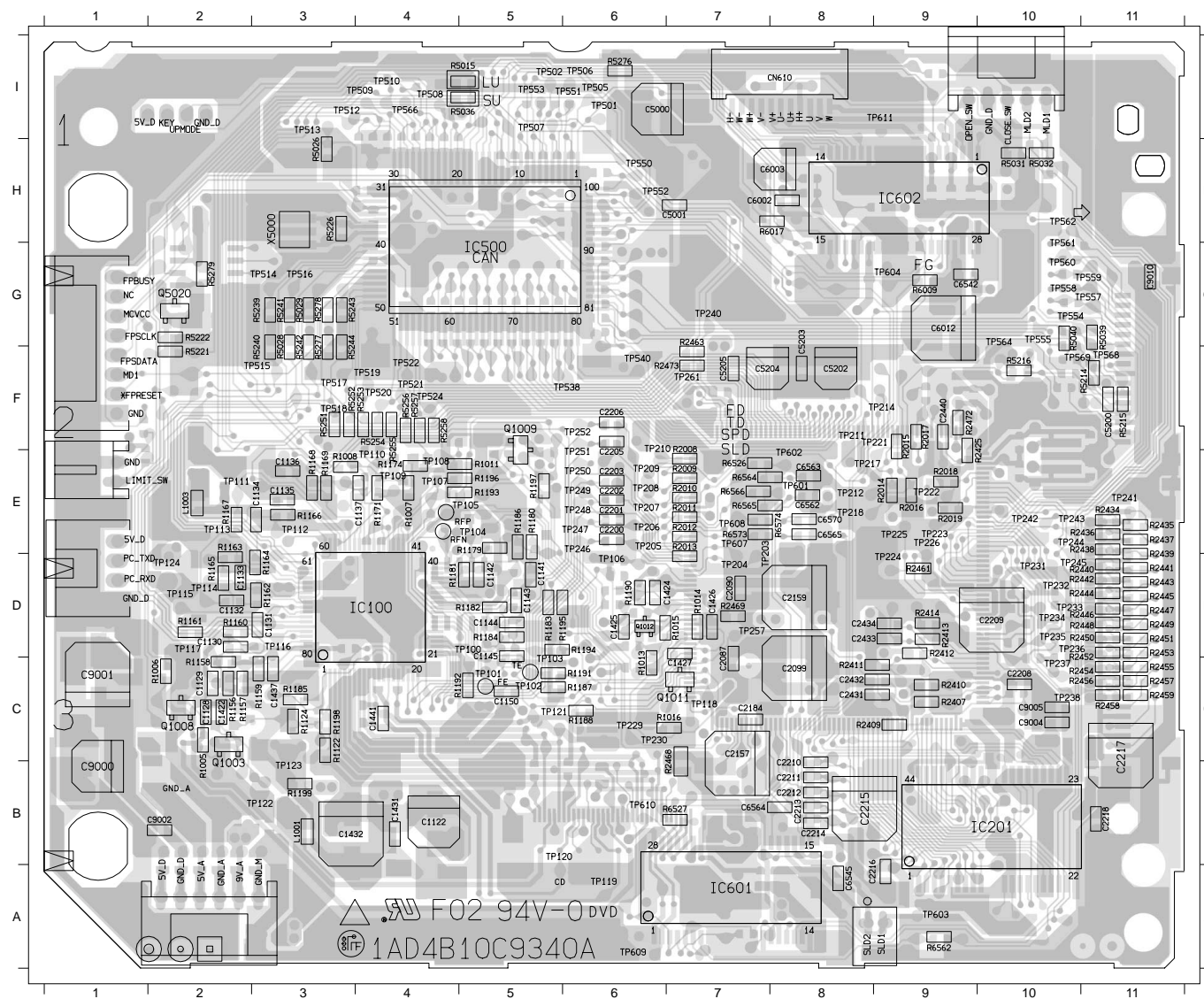

C1113	C4	C1425	D6	C2210	B8	C6006	H9	IC101	D5	R1012	D5	R1180	E5	R2020	F9	R2445	D11	R5022	I4	R5204	F10	R5260	G5	R6565	E8	TP202	D6	TP240	G7	TP520	F4	TP563	F1
C1114	C4	C1426	D7	C2211	B8	C6007	A8	IC200	D8	R1013	C6	R1181	D5	R2040	D6	R2446	D11	R5024	H4	R5205	G10	R5261	G5	R6566	E7	TP203	D7	TP241	E11	TP521	F4	TP564	G10
C1115	C3	C1427	D7	C2212	B8	C6008	A8	IC500	B10	R1014	D7	R1182	D5	R2084	D6	R2447	D11	R5026	H3	R5206	G10	R5262	G5	R6568	F1	TP204	D7	TP242	E10	TP522	F4	TP565	G6
C1117	C2	C1428	E5	C2213	B8	C6009	G9	IC201	G5	R1015	D6	R1183	D5	R2407	C9	R2448	D11	R5027	H4	R5208	G10	R5263	G5	R6569	E1	TP205	E6	TP243	E10	TP523	F4	TP566	I4
C1118	C3	C1429	D3	C2214	B8	C6011	G9	IC502	G2	R1016	C7	R1184	D5	R2408	C10	R2449	D11	R5028	F3	R5209	G10	R5264	G5	R6573	E7	TP206	E6	TP244	E10	TP524	F4	TP567	F5
C1120	D3	C1430	D2	C2215	B8	C6012	G9	IC504	F10	R1017	E4	R1185	C3	R2409	C9	R2450	D11	R5029	G3	R5210	G10	R5265	G5	R6574	E7	TP207	E6	TP245	D10	TP530	G5	TP568	F11
C1121	B4	C1431	B4	C2216	A9	C6503	B7	IC601	A7	R1018	C2	R1186	E5	R2410	C9	R2451	D11	R5031	H10	R5211	G10	R5266	G5	R9000	B2	TP208	E6	TP246	E6	TP531	F5	TP569	F10
C1122	B4	C1432	B3	C2217	C11	C6542	G9	IC602	H9	R1019	C2	R1187	C5	R2411	C9	R2452	D11	R5032	H10	R5212	G10	R5267	G5	R9001	B2	TP209	E6	TP247	E6	TP532	G5	TP601	E8
C1128	C2	C1433	D4	C2218	B11	C6545	A8	IC900	C1	R1122	C3	R1188	C6	R2412	D9	R2453	D11	R5033	I5	R5213	G10	R5268	G5	R9002	B2	TP210	E6	TP248	E6	TP533	F5	TP602	E8
C1129	C2	C1434	D4	C2431	C9	C6560	B8	L1001	B3	R1124	C3	R1189	D5	R2413	D9	R2454	C11	R5034	H5	R5214	F11	R5269	G5	R9003	B2	TP211	F8	TP249	E6	TP534	G5	TP603	A9
C1130	D2	C1435	E3	C2432	C9	C6562	E8	L1002	D3	R1125	E4	R1190	D6	R2414	D9	R2455	C11	R5035	H5	R5215	F11	R5270	G5	R9004	B2	TP212	E8	TP250	E6	TP535	F5	TP604	G9
C1131	D3	C1436	E2	C2433	D9	C6563	E8	L1003	E2	R1126	D5	R1191	C5	R2415	D10	R2456	C11	R5036	I5	R5216	F10	R5271	G5	R9005	B3	TP213	F8	TP251	E6	TP536	G6	TP605	H8
C1132	D2	C1437	C3	C2434	D9	C6564	B8	L1004	D2	R1128	E4	R1192	C5	R2416	D10	R2457	C11	R5037	H4	R5221	F2	R5272	G6	TP100	D5	TP214	F9	TP252	F6	TP537	F6	TP606	H8
C1133	D2	C1438	D5	C2435	C10	C6565	E8	L1005	B6	R1129	E4	R1193	E5	R2417	D10	R2458	C11	R5038	H4	R5222	G2	R5273	G6	TP101	C5	TP215	F9	TP253	E6	TP538	F6	TP607	E7
C1134	E3	C1439	D5	C2436	D10	C6570	E8	L2001	C10	R1132	B6	R1194	D5	R2418	D10	R2459	C11	R5039	G11	R5223	I9	R5274	G6	TP102	C5	TP216	F9	TP254	E6	TP539	F6	TP608	E7
C1135	E3	C1440	D5	C2437	D10	C9000	B1	L9001	B2	R1133	B5	R1195	D5	R2419	D10	R2460	D10	R5040	G10	R5224	I9	R5275	G6	TP103	C5	TP217	E8	TP256	F6	TP540	F6	TP609	A6
C1136	E3	C1441	C4	C2438	E11	C9001	C1	Q1002	E4	R1137	C3	R1196	E5	R2422	D10	R2461	D9	R5041	G4	R5226	H3	R5276	I6	TP104	E5	TP218	E8	TP257	D7	TP541	F6	TP610	B6
C1137	E4	C2001	C6	C2439	F11	C9002	B2	Q1003	C2	R1141	D3	R1197	E5	R2423	E10	R2463	F7	R5042	G4	R5228	G8	R5277	F3	TP105	E5	TP219	F9	TP258	C7	TP542	G6	TP611	I9
C1138	E3	C2002	D6	C2440	F9	C9003	B3	Q1004	C2	R1156	C2	R1198	C3	R2424	F10	R2466	B11	R5043	G4	R5229	I5	R5278	G3	TP106	D6	TP220	F9	TP259	B7	TP543	G6	X2000	E10
C1139	E4	C2020	D6	C2441	F9	C9004	C10	Q1005	D2	R1157	C2	R1199	B3	R2425	E9	R2467	F6	R5044	G4	R5239	G3	R5279	G2	TP107	E4	TP221	F9	TP260	B7	TP544	G6	TP560	H8
C1140	F5	C2021	D6	C2442	F7	C9005	C10	Q1008	C2	R1158	C2	R2001	E6	R2426	F9	R2468	B7	R5045	G4	R5240	F3	R6009	G9	TP108	E4	TP222	E9	TP261	F7	TP545	G6		
C1141	D5	C2022	D6	C5000	I6	C9006	I9	Q1009	E5	R1159	C3	R2002	E6	R2427	F9	R2469	D7	R5046	G4	R5241	G3	R6010	H8	TP109	E4	TP223	E9	TP501	I6	TP546	H5		
C1142	D5	C2083	D6	C5001	H7	C9007	A4	Q1010	E5	R1160	D2	R2003	E6	R2428	B8	R2470	D6	R5047	G4	R5242	F3	R6011	H8	TP110	E4	TP224	D9	TP502	I6	TP547	H5		
C1143	D5	C2087	C7	C5002	H4	C9008	A2	Q1011	C7	R1161	D2	R2004	E6	R2429	B8	R2471	C10	R5048	G5	R5243	G3	R6012	G9	TP111	E2	TP225	E9	TP505	I6	TP548	I5		
C1144	D5	C2090	D7	C5020	G2	C9009	I3	Q1012	D6	R1162	D3	R2006	F6	R2430	B8	R2472	F9	R5049	F10	R5244	F3	R6013	G9	TP112	E2	TP226	E9	TP506	I6	TP549	I4		
C1145	C5	C2099	C8	C5021	H2	C9010	G11	Q1013	E5	R1163	D2	R2007	F6	R2431	B8	R2473	F7	R5066	G6	R5247	H6	R6014	G9	TP113	E2	TP227	C10	TP507	I5	TP550	H6		
C1146	C4	C2157	C7	C5031	H10	CN100	B6	Q1014	E4	R1164	D3	R2008	E7	R2432	B8	R5003	I6	R5067	G6	R5248	H6	R6015	H9	TP114	D2	TP228	B7	TP508	I4	TP551	I6		
C1148	D5	C2159	D8	C5200	F11	CN200	D11	Q5020	G2	R1165	D2	R2009	E7	R2434	E11	R5004	H5	R5068	G6	R5249	H6	R6016	I8	TP115	D2	TP229	C6	TP509	I4	TP552	H6		
C1149	C5	C2184	C7	C5202	F8	CN500	F11	R1001	B4	R1166	E3	R2010	E7	R2435	E11	R5005	H6	R5069	G6	R5250	I6	R6017	H8	TP116	D3	TP230	C6	TP510	I4	TP553	I5		
C1150	C5	C2200	E6	C5203	F8	CN510	H1	R1003	C2	R1167	E2	R2011	E7	R2436	E11	R5006	I5	R5070	G6	R5251	F3	R6020	H8	TP117	D2	TP231	D10	TP511	I3	TP554	G10		
C1151	F5	C2201	E6	C5204	F7	CN540	D1	R1004	C2	R1168	E3	R2012	E7	R2437	E11	R5007	H5	R5071	H6	R5252	F3	R6021	A7	TP118	C7	TP232	D10	TP512	I3	TP555	G10		
C1152	D5	C2202	E6	C5205	F7	CN600	I10	R1005	C2	R1169	E3	R2013	D7	R2438	E11	R5008	H5	R5072	H6	R5253	F4	R6024	A6	TP119	A6	TP233	D10	TP513	I3	TP556	G9		
C1153	F5	C2203	E6	C5206	F10	CN610	I8	R1006	C2	R1170	E4	R2014	E9	R2439	D11	R5015	I5	R5073	H6	R5254	F4	R6508	B8	TP120	B5	TP234	D10	TP514	G3	TP557	G11		
C1418	C4	C2205	F6	C6001	G9	CN620	A9	R1007	E4	R1171	E4	R2015	F9	R2440	D11	R5017	H4	R5075	H6	R5255	F4	R6509	B8	TP121	C5	TP235	D10	TP515	F3	TP558	G10		
C1420	C4	C2206	F6	C6002	H8	CN630	E1	R1008	E3	R1172	E4	R2016	E9	R2441	D11	R5018	H4	R5076	H6	R5256	F4	R6526	E7	TP122	B3	TP236	D10	TP516	G3	TP559	G11		
C1421	C4	C2207	F7	C6003	H8	CN900	A3	R1009	F4	R1174	E4	R2017	F9	R2442	D11	R5019	H4	R5077	G6	R5257	F4	R6527	B7	TP123	B3	TP237	C10	TP517	F3	TP560	G10		
C1422	C2	C2208	C10	C6004	H9	D601	H10	R1010	E5	R1176	E5	R2018	E9	R2443	D11	R5020	I4	R5080	H4	R5258	F4	R6562	A9	TP124	D2	TP238	C10	TP518	F3	TP561	G10		
C1424	D6	C2209	D10	C6005	H9	IC100	D4	R1011	E5	R1179	E5	R2019	E9	R2444	D11	R5021	H4	R5203	F10	R5259	G5	R6564	E8	TP201	C6	TP239	D6	TP519	F4	TP562	H10		

SMD Bestückung der Unterseite – Ansicht von der Lötseite / SMD Assembly of the Lower Side – View of the Solder Side

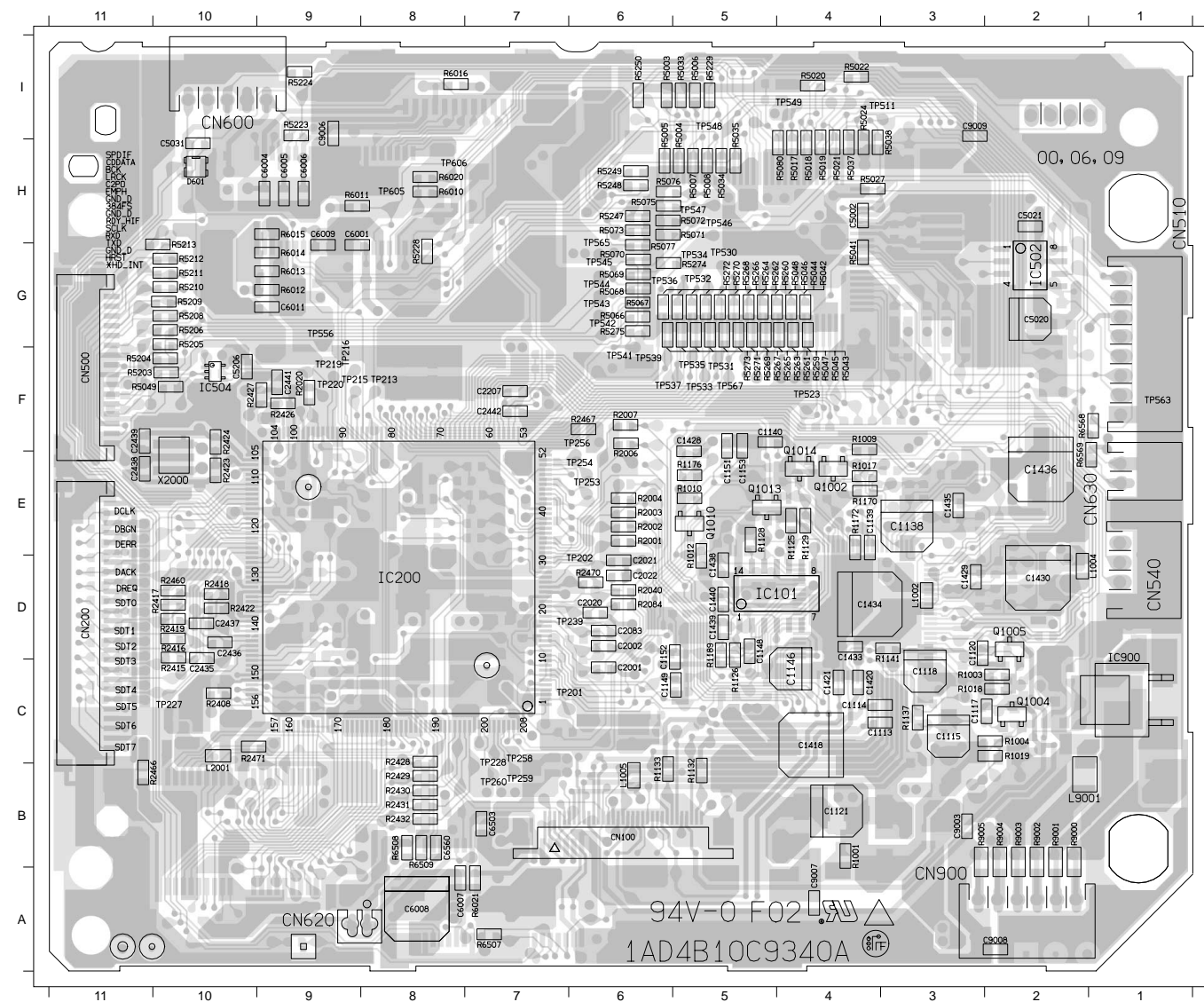

R5022	I4	R5204	F10	R5260	G5	R6565	E8	TP202	D6	TP240	G7	TP520	F4	TP563	F1
R5024	H4	R5205	G10	R5261	G5	R6566	E7	TP203	D7	TP241	E11	TP521	F4	TP564	G10
R5026	H3	R5206	G10	R5262	G5	R6568	F1	TP204	D7	TP242	E10	TP522	F4	TP565	G6
R5027	H4	R5208	G10	R5263	G5	R6569	E1	TP205	E6	TP243	E10	TP523	F4	TP566	I4
R5028	F3	R5209</													

Laufwerkplatte / Drive Board – GDV 120/02

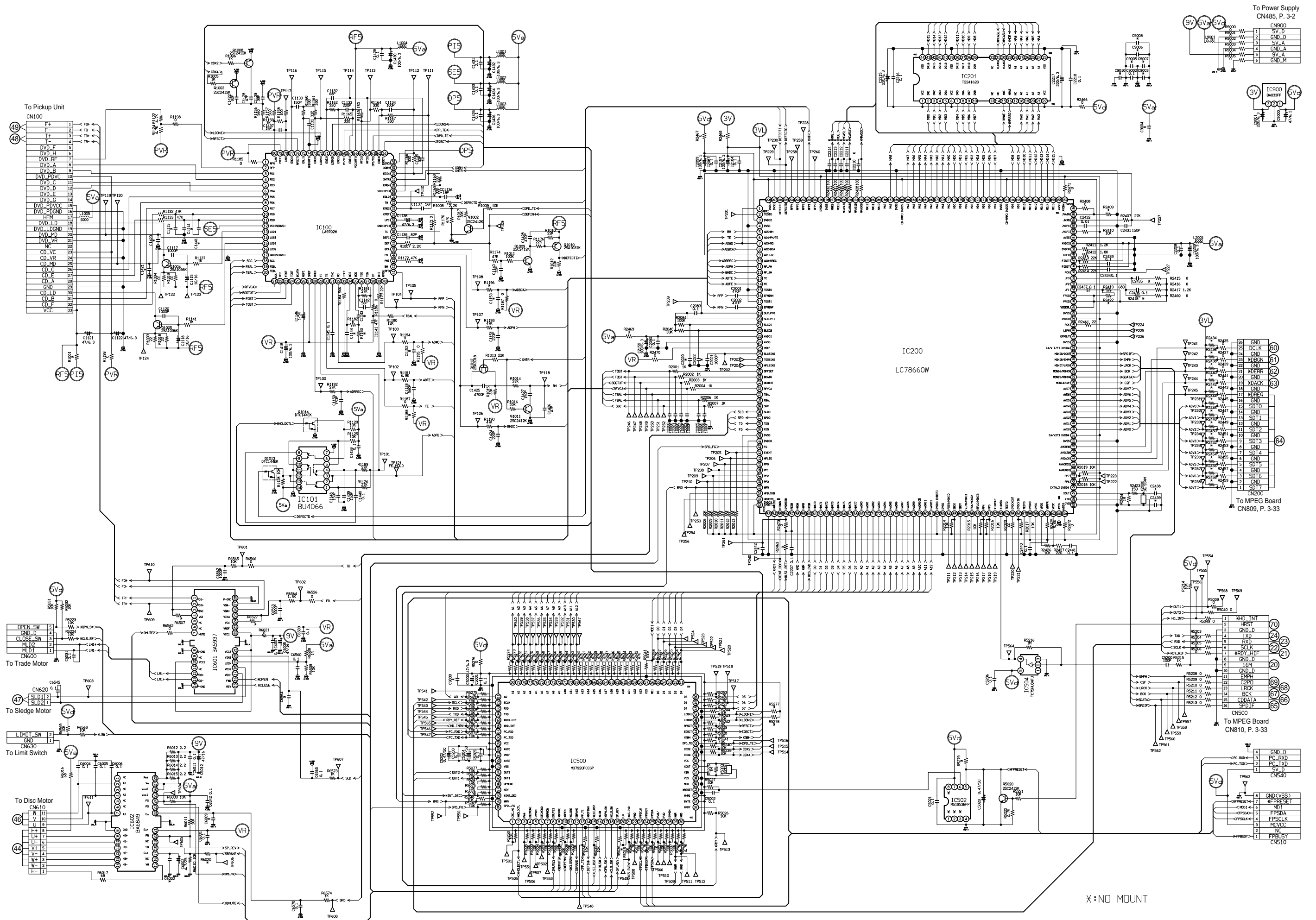

Laufwerkplatte / Drive Board – GDV 120/02 (vergrößert / enlarged)

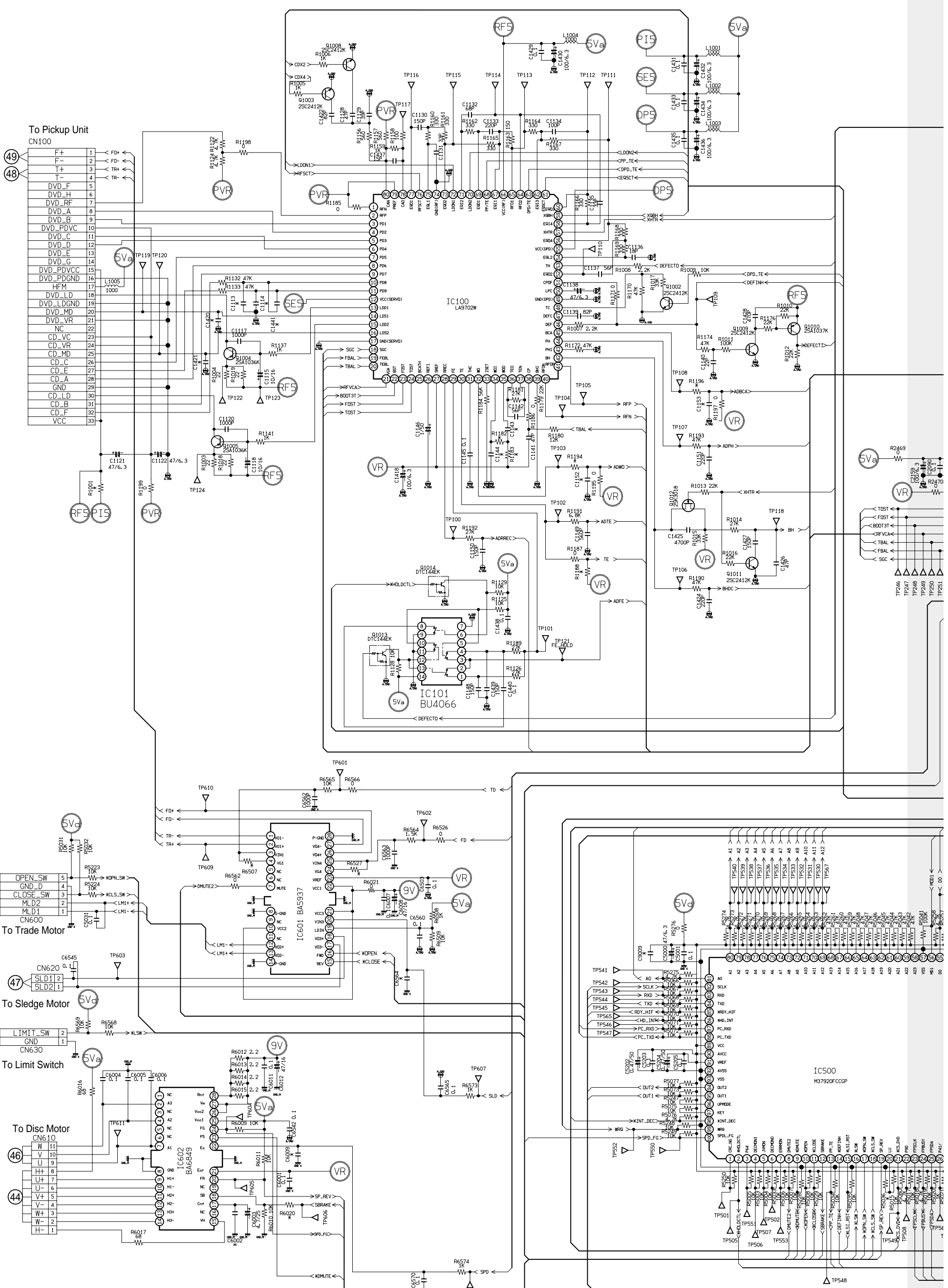

To Power Supply

CN900	
1	5V_D
2	GND_D
3	5V_A
4	GND_A
5	9V_A
6	GND_M

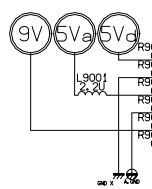
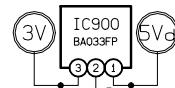

To MPEG Board

CN200	
26	GND
25	DCLK
24	GND
23	XDBGN
22	GND
21	XDERR
20	GND
19	XDACK
18	GND
17	XDREQ
16	GND
15	SDTO
14	GND
13	SDT1
12	GND
11	SDT2
10	GND
9	SDT3
8	GND
7	SDT4
6	GND
5	SDT5
4	GND
3	SDT6
2	GND
1	SDT7

To MPEG Board

CN809	
1	SDT7
2	GND
3	SDT6
4	GND
5	SDT5
6	GND
7	SDT4
8	GND
9	SDT3
10	GND
11	SDT2
12	GND
13	SDT1
14	GND
15	SDTO
16	GND
17	XDREQ
18	GND
19	XDACK
20	GND
21	XDERR
22	GND
23	XDBGN
24	GND
25	DCLK
26	GND

To MPEG Board

CN810	
1	SPDIF
2	GND
3	SDT6
4	GND
5	SDT5
6	GND
7	SDT4
8	GND
9	SDT3
10	GND
11	SDT2
12	GND
13	SDT1
14	GND
15	SDTO
16	GND
17	XDREQ
18	GND
19	XDACK
20	GND
21	XDERR
22	GND
23	XDBGN
24	GND
25	DCLK
26	GND

To MPEG Board

CN500	
1	SPDIF
2	GND
3	SDT6
4	GND
5	SDT5
6	GND
7	SDT4
8	GND
9	SDT3
10	GND
11	SDT2
12	GND
13	SDT1
14	GND
15	SDTO
16	GND
17	XDREQ
18	GND
19	XDACK
20	GND
21	XDERR
22	GND
23	XDBGN
24	GND
25	DCLK
26	GND

To MPEG Board

CN540	
1	FPBUSY
2	NC
3	MCVCC
4	FPSClk
5	FPSDA
6	MDI
7	XFPRESET
8	GND(VSS)

To MPEG Board

CN500	
1	SPDIF
2	GND
3	SDT6
4	GND
5	SDT5
6	GND
7	SDT4
8	GND
9	SDT3
10	GND
11	SDT2
12	GND
13	SDT1
14	GND
15	SDTO
16	GND
17	XDREQ
18	GND
19	XDACK
20	GND
21	XDERR
22	GND
23	XDBGN
24	GND
25	DCLK
26	GND

To MPEG Board

CN500	
1	SPDIF
2	GND
3	SDT6
4	GND
5	SDT5
6	GND
7	SDT4
8	GND
9	SDT3
10	GND
11	SDT2
12	GND
13	SDT1
14	GND
15	SDTO
16	GND
17	XDREQ
18	GND
19	XDACK
20	GND
21	XDERR
22	GND
23	XDBGN
24	GND
25	DCLK
26	GND

To MPEG Board

CN500	
1	SPDIF
2	GND
3	SDT6
4	GND
5	SDT5
6	GND
7	SDT4
8	GND
9	SDT3
10	GND
11	SDT2
12	GND
13	SDT1
14	GND
15	SDTO
16	GND
17	XDREQ
18	GND
19	XDACK
20	GND
21	XDERR
22	GND
23	XDBGN
24	GND
25	DCLK
26	GND

To MPEG Board

CN500	
1	SPDIF
2	GND
3	SDT6
4	GND
5	SDT5
6	GND
7	SDT4
8	GND
9	SDT3
10	GND
11	SDT2
12	GND
13	SDT1
14	GND
15	SDTO
16	GND
17	XDREQ
18	GND
19	XDACK
20	GND
21	XDERR
22	GND
23	XDBGN
24	GND
25	DCLK
26	GND

To MPEG Board

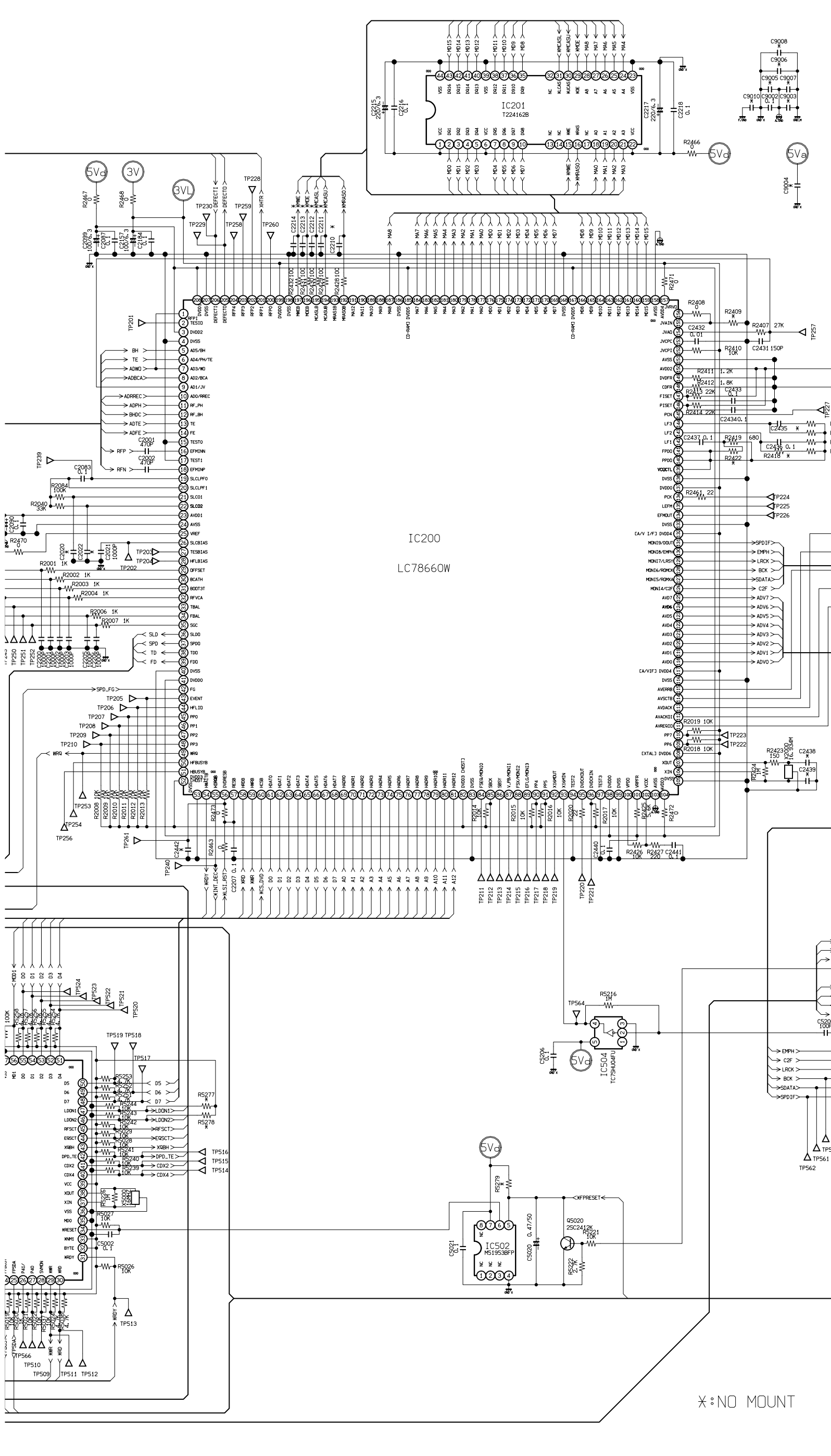

*: NO MOUNT

Oszillogramme / Oscillograms

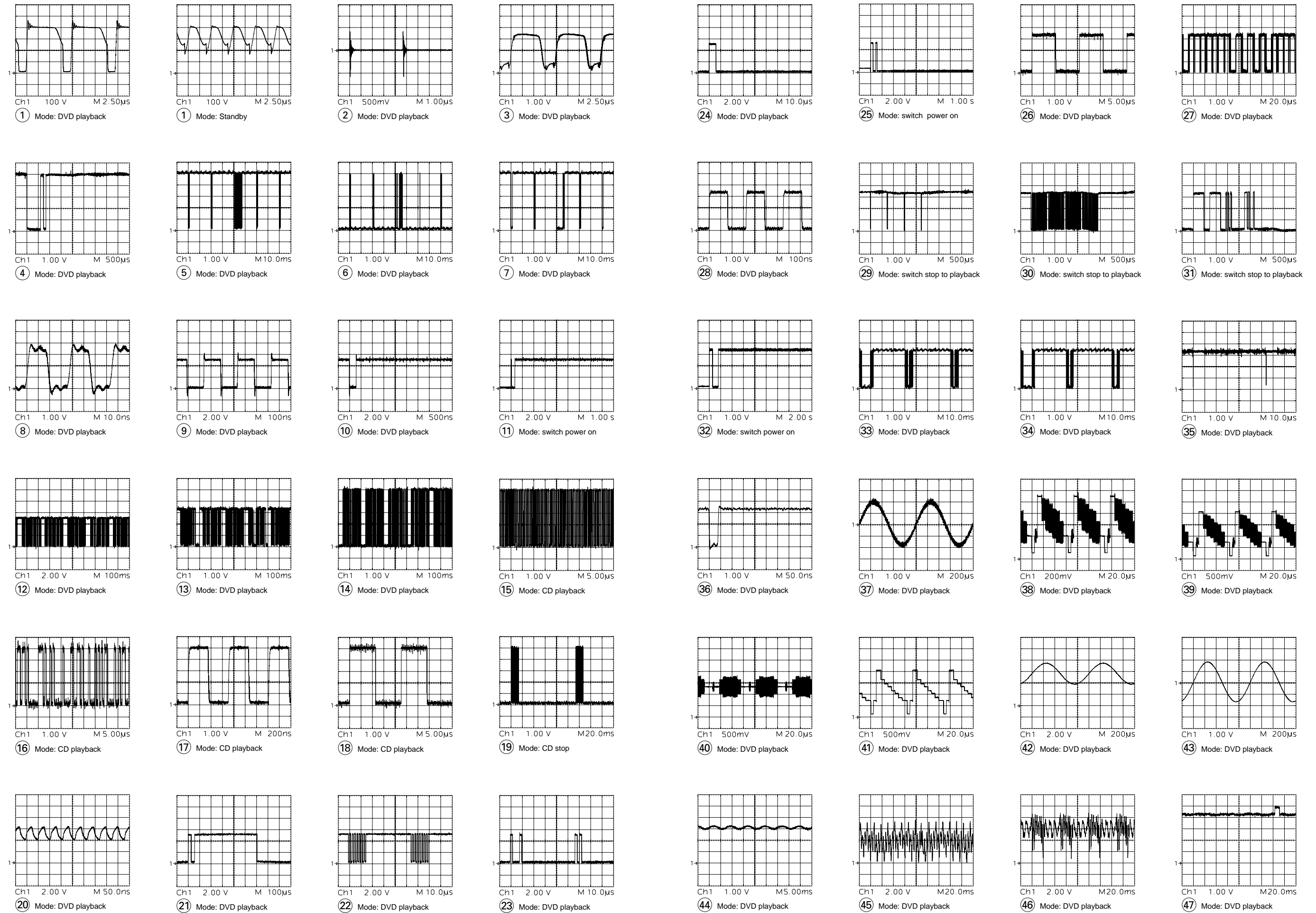

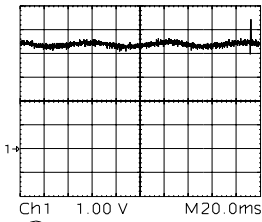

48 Mode: DVD playback

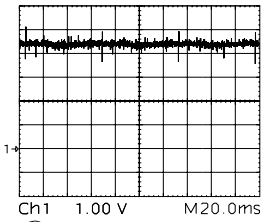

49 Mode: DVD playback

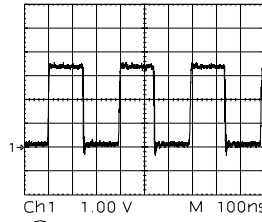

60 Mode: DVD playback

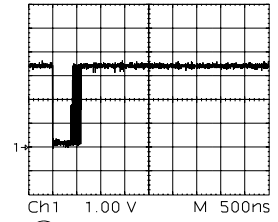

61 Mode: DVD playback

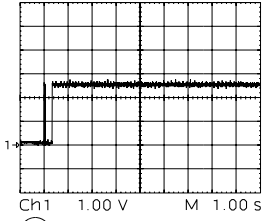

62 Mode: switch power on

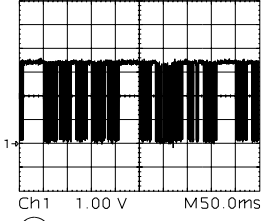

63 Mode: DVD playback

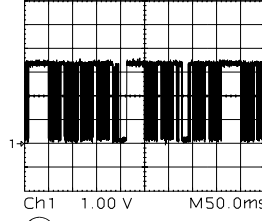

64 Mode: DVD playback

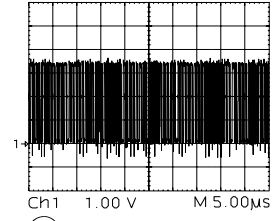

65 Mode: CD playback

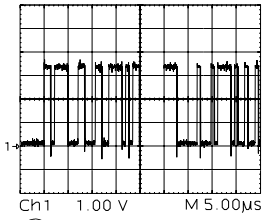

66 Mode: CD playback

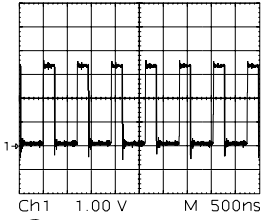

67 Mode: CD playback

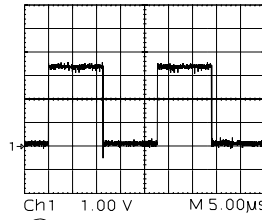

68 Mode: CD playback

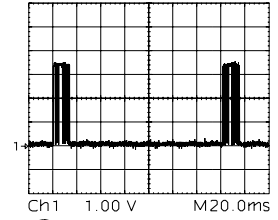

69 Mode: CD stop

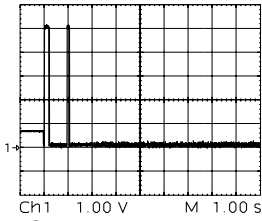

70 Mode: DVD playback

DC-Spannungen / DC Voltages

Pos.	Voltage indications: GDV120																			
	Power off										Power on									
IC101	1 0V	2 0V	3 0V	4 0V	5 0.1V	6 0.1V	7 0V	8 0.1V			1 0V	2 0V	3 0V	4 0V	5 3.3V	6 3.3V	7 0V	8 3.3V		
IC102	1 0.1V	2 0.1V	3 0.1V	4 0.1V	5 0.1V	6 0.1V	7 0.1V	8 0.1V	9 0.1V	10 0V	1 3.3V	2 0.8V	3 0.6V	4 1.1V	5 3.3V	6 3.3V	7 3.3V	8 3.3V	9 3.3V	10 0V
	11 0.1V	12 0.1V	13 0.1V	14 0.1V	15 0.1V	16 0.1V	17 0.1V	18 0.1V	19 0V	20 0.1V	11 3.3V	12 3.3V	13 3.3V	14 3.3V	15 3.3V	16 3.3V	17 2.5V	18 3.3V	19 0V	20 3.3V
	21 0V	22 0.1V	23 0.1V	24 0.1V	25 0V	26 0V	27 0V	28 0.1V	29 0V	30 0.1V	21 0V	22 3.3V	23 3.3V	24 3.3V	25 1.2V	26 0.8V	27 0.8V	28 3.3V	29 0V	30 3.3V
	31 0V	32 0V	33 0V	34 0V	35 0V	36 0V	37 0.1V	38 0.2V	39 0.1V	40 0.1V	31 0.7V	32 0.4V	33 1.2V	34 1.2V	35 0V	36 0V	37 3.2V	38 0.9V	39 0.9V	40 0.6V
	41 0.1V	42 0.1V	43 0V	44 0V							41 1.3V	42 2.5V	43 0V	44 1.6V						
IC103	1 0.6V	2 0V	3 0V								1 5.1V	2 0V	3 2.5V							
IC104	1 0.6V	2 0V	3 0.1V								1 5.1V	2 0V	3 3.3V							
IC110	1 0.1V	2 0V	3 0V	4 0V	5 0V	6 0V	7 0.1V	8 0V	9 0V	10 0V	1 3.3V	2 -	3 -	4 0V	5 -	6 -	7 3.3V	8 -	9 -	10 0V
	11 0V	12 0V	13 0.1V	14 0.1V	15 0.1V	16 0.1V	17 0.1V	18 0.1V	19 0.1V	20 0.1V	11 -	12 -	13 3.3V	14 0V	15 3.3V	16 3V	17 3.1V	18 3.1V	19 0.2V	20 0V
	21 -	22 -	23 0.5V	24 -	25 0.1V	26 0V	27 -	28 -	29 0V	30 0V	21 0V	22 0V	23 0.2V	24 0.2V	25 3.3V	26 0V	27 0.2V	28 0.2V	29 0.2V	30 0.2V
	31 0.1V	32 0.1V	33 0V	34 0.1V	35 0.1V	36 0.1V	37 0V	38 0.1V	39 0V	40 0V	31 0V	32 0V	33 0V	34 3.3V	35 1.6V	36 0V	37 0V	38 3.3V	39 -	40 -
	41 0V	42 0V	43 0V	44 0.1V	45 0V	46 0V	47 0V	48 0V	49 0V	50 0V	41 0V	42 -	43 -	44 3.3V	45 -	46 -	47 0V	48 -	49 -	50 0V
IC111	1 0.1V	2 0V	3 0V	4 0V	5 0V	6 0V	7 0.1V	8 0V	9 0V	10 0V	1 3.3V	2 -	3 -	4 0V	5 -	6 -	7 3.3V	8 -	9 -	10 0V
	11 0V	12 0V	13 0.1V	14 0.1V	15 0.1V	16 0.1V	17 0.1V	18 0V	19 0.1V	20 0.1V	11 -	12 -	13 3.3V	14 0V	15 3.3V	16 3V	17 3.1V	18 3V	19 0.2V	20 0V
	21 -	22 -	23 -	24 -	25 0.1V	26 0V	27 0.5V	28 -	29 0.1V	30 0.1V	21 0V	22 0V	23 0.2V	24 0.2V	25 3.3V	26 0V	27 0.2V	28 0.2V	29 0.2V	30 0.2V
	31 0.1V	32 0.1V	33 0V	34 0.1V	35 0.1V	36 0.1V	37 0V	38 0.1V	39 0V	40 0V	31 0V	32 0V	33 0V	34 3.3V	35 1.6V	36 0V	37 0V	38 3.3V	39 -	40 -
	41 0V	42 0V	43 0V	44 0.1V	45 0V	46 0V	47 0V	48 0V	49 0V	50 0V	41 0V	42 -	43 -	44 3.3V	45 -	46 -	47 0V	48 -	49 -	50 0V
IC112	1 0V	2 0V	3 0V	4 0V	5 0V	6 0.5V	7 0V	8 2V	9 0V	10 0V	1 0V	2 0.1V	3 3.3V	4 5V	5 3.3V	6 0.1V	7 3.3V	8 4.9V	9 0V	10 0V
	11 0V	12 0V	13 0.6V	14 0V	15 0V	16 0V	17 0.6V	18 0V	19 0V	20 0V	11 0V	12 3.3V	13 5V	14 0V	15 5V	16 3.3V	17 5V	18 0V	19 0V	20 3.3V
IC113	1 0V	2 0V	3 0.7V	4 0V	5 0.6V	6 0V	7 1.2V	8 0V	9 1.6V	10 0V	1 0V	2 0V	3 0V	4 0V	5 5V	6 0V	7 5V	8 0V	9 4.9V	10 0V
	11 0.1V	12 1.2V	13 0V	14 0.5V	15 0V	16 0.5V	17 0V	18 0.7V	19 0V	20 0.6V	11 3.2V	12 0V	13 3.3V	14 0V	15 3.3V	16 0V	17 0V	18 0V	19 0V	20 5V

Pos.	Voltage indications: GDV120																			
	Power off										Power on									
IC116	1	2	3	4	5	6	7	8	9	10	1	2	3	4	5	6	7	8	9	10
	0V	0V	0.1V	0.1V	0.1V	0.1V	0.1V	0.1V	0.1V	0.1V	0V	2.5V	3.3V	0V	0V	0V	0V	0V	0V	0V
	11	12	13	14	15	16	17	18	19	20	11	12	13	14	15	16	17	18	19	20
	0.1V	0.1V	0.1V	0.1V	0V	0.1V	0.1V	0.1V	0V	0.1V	0V	3.3V	3.3V	3.3V	0V	3.3V *1	3.3V *2	3.3V	0V	3.3V
	21	22	23	24	25	26	27	28	29	30	21	22	23	24	25	26	27	28	29	30
	0.1V	0V	0V	0.1V	0.1V	0V	0V	0.1V	0V	0V	3.3V	0V	0V *2	3.3V	3.3V	0V	0V	3.3V	0V	0V
	31	32	33	34	35	36	37	38	39	40	31	32	33	34	35	36	37	38	39	40
	0V	0V	0V	0V	0.1V	0.1V	0.1V	0V	0V	0V	0V	0V	0V	0V	3.3V	3.3V	0V	3.3V	2.5V	0V
	41	42	43	44	45	46	47	48	49	50	41	42	43	44	45	46	47	48	49	50
	0.1V	0V	0.1V	0V	0V	0.1V	0.1V	0V	0V	0V	3.3V	0V	3.2V	0.1V	-	3.2V	3.3V	2.7V	0V	0V
	51	52	53	54	55	56	57	58	59	60	51	52	53	54	55	56	57	58	59	60
	0V	0V	0V	0V	0V	0.1V	0V	0V	0.1V	0.1V	0V	2.5V	2.5V	0V	1.6V	3.2V	3.3V	3.3V	3.3V	0V
	61	62	63	64	65	66	67	68	69	70	61	62	63	64	65	66	67	68	69	70
	0.1V	0.1V	0.1V	0.1V	0V	0V	0V	0V	0V	0.1V	0V	3.3V	3.3V	3.3V	0V	0V	3.3V	0V	0V	0V
	71	72	73	74	75	76	77	78	79	80	71	72	73	74	75	76	77	78	79	80
	0.1V	0V	0.1V	0.1V	0V	0.1V	0.1V	0.1V	0V	0.1V	3.3V	0V	0V	3.3V	3.2V	3.3V	3.3V	3.3V	3V	0V
81	82	83	84	85	86	87	88	89	90	81	82	83	84	85	86	87	88	89	90	
0V	0V	0V	0.1V	0V	0.1V	0.1V	0.1V	0.1V	0.1V	0V	2.5V	3.3V	3.3V	3.3V	3.3V	0V	3.3V	3.3V	3.3V	
91	92	93	94	95	96	97	98	99	100	91	92	93	94	95	96	97	98	99	100	
0.1V	0V	0V	0.1V	0.1V	0V	0.1V	0V	0V	0V	3.3V	0V	3.3V	3.2V	3.3V	0V	3.3V	0V	3.3V	3.3V	
101	102	103	104	105	106	107	108	109	110	101	102	103	104	105	106	107	108	109	110	
0V	0V	0V	0V	0V	0V	0V	0V	0V	0.1V	3.3V	-	-	-	-	-	-	-	0V	3.3V	
111	112	113	114	115	116	117	118	119	120	111	112	113	114	115	116	117	118	119	120	
0V	0.1V	0.1V	0.1V	0.1V	0.1V	0.1V	0.1V	0.1V	0.1V	-	0V	3.3V	3.2V	3.3V	3.2V	3.3V	0.2V	0.2V	3.3V	
121	122	123	124	125	126	127	128	129	130	121	122	123	124	125	126	127	128	129	130	
0V	0V	0.1V	0.1V	0V	0V	0V	0V	0V	0V	0V	2.5V	1.6V	0V	-	-	-	-	-	0V	
131	132	133	134	135	136	137	138	139	140	131	132	133	134	135	136	137	138	139	140	
0.1V	0V	0V	0V	0.1V	0.1V	0.1V	0.1V	0.1V	0V	3.3V	-	-	1.3V	3.3V	3.3V	3.3V	3V	3V	0V	
141	142	143	144	145	146	147	148	149	150	141	142	143	144	145	146	147	148	149	150	
0.1V	0.1V	0.1V	0.1V	0.1V	0.1V	0.1V	0V	0V	0V	3.3V	0V	3.3V	0V	0V	0V	0V	0V	0V	0V	
151	152	153	154	155	156	157	158	159	160	151	152	153	154	155	156	157	158	159	160	
0.1V	0V	0V	0V	0V	0V	0V	0V	0V	0.1V	3.3V	0V	0V	0V	0V	0V	0V	0V	0V	3.3V	
IC117	1	2	3	4	5	6	7	8	9	10	1	2	3	4	5	6	7	8	9	10
	0.1V	0V	0V	0V	0V	0V	0.1V	0V	0V	0V	3.3V	-	-	0V	-	-	3.3V	-	-	0V
	11	12	13	14	15	16	17	18	19	20	11	12	13	14	15	16	17	18	19	20
	0V	0V	0.1V	0.1V	0.1V	0.1V	0.1V	0.1V	0.1V	0.1V	-	-	3.3V	0V	3.3V	3.3V	3.3V	3.3V	0V	0V
	21	22	23	24	25	26	27	28	29	30	21	22	23	24	25	26	27	28	29	30
0.1V	0.1V	0.1V	0.1V	0.1V	0V	0.1V	0.1V	0.1V	0.1V	3.3V	3.3V	3.3V	0V	3.3V	0V	0V	0.1V	3.3V	0V	
31	32	33	34	35	36	37	38	39	40	31	32	33	34	35	36	37	38	39	40	
0.1V	0.1V	0V	0.1V	0.1V	0.1V	0V	0.1V	0V	0V	0.1V	0.1V	0V	3.3V	1.6V	0V	0V	3.3V	-	-	
41	42	43	44	45	46	47	48	49	50	41	42	43	44	45	46	47	48	49	50	
0V	0V	0V	0.1V	0V	0V	0V	0V	0V	0V	0V	-	-	3.3V	-	-	0V	-	-	0V	
IC118	1	2	3	4	5	6	7	8	9	10	1	2	3	4	5	6	7	8	9	10
	0V	0V	0V	0V	0V	0V	0.1V	0.1V	0V	0V	0.2V	-	0.1V	0.1V	0.1V	3.3V	0V	-	3.3V	0V
	11	12	13	14	15	16	17	18	19	20	11	12	13	14	15	16	17	18	19	20
	0V	0V	0V	0.1V	0V	0V	0V	0.1V	0.1V	0.1V	0V	0V	0V	3.3V	0V	0V	0V	0.1V	0V	3.3V
	21	22	23	24	25	26	27	28	29	30	21	22	23	24	25	26	27	28	29	30
0.1V	0.1V	0.1V	0V	0.1V	0.1V	0V	0V	0V	0V	0V	3.3V	3.3V	3.3V	3.3V	3.3V	0V	3.3V	-	-	
31	32	33	34	35	36	37	38	39	40	31	32	33	34	35	36	37	38	39	40	
0V	0V	0V	0V	0V	0V	0.1V	0V	0V	0V	-	-	-	-	-	-	3.3V	0V	1.3V	-	
41	42	43	44	45	46	47	48			41	42	43	44	45	46	47	48			
0V	0V	0V	0V	0V	0V	0V	0V			-	-	-	1.3V	1.3V	-	0V	0V			

Pos.	Voltage indications: GDV120																			
	Power off										Power on									
IC127	1	2	3	4	5	6	7	8	9	10	1	2	3	4	5	6	7	8	9	10
	0V	0V	0V	0V	0V	0.1V	0V	0V	0V	0V	0V	-	-	-	-	3.3V	-	-	-	-
	11	12	13	14	15	16	17	18	19	20	11	12	13	14	15	16	17	18	19	20
	0V	0.4V	0.4V	0.4V	0.4V	0.4V	0.4V	0.4V	0.4V	0V	0V	0V	0V	0V	0V	0V	0V	0V	5V	0V
	21	22	23	24	25	26	27	28	29	30	21	22	23	24	25	26	27	28	29	30
	0.1V	1.3V	1.5V	0.1V	0.1V	0.1V	0.1V	0.4V	0.1V	0.3V	5V	0V	0V	0V	3.3V	5V	3.3V	2.5V	3.3V	0.1V
	31	32	33	34	35	36	37	38	39	40	31	32	33	34	35	36	37	38	39	40
	0V	0V	0V	0.1V	0.1V	0.1V	0.1V	0.1V	0.1V	0.1V	0V	0V	0V	0.2V	3.1V	3.3V	3.3V	0V	0V	3.3V
	41	42	43	44	45	46	47	48	49	50	41	42	43	44	45	46	47	48	49	50
	0V	0.1V	0.1V	0.1V	0.1V	0V	0V	0V	0V	0V	0V	3.3V	3.3V	3.3V	3.3V	0V	-	-	-	-
	51	52	53	54	55	56	57	58	59	60	51	52	53	54	55	56	57	58	59	60
	0V	0V	0V	0V	0V	0V	0.1V	0.1V	0.1V	0V	-	-	-	-	0V	1.6V	3.3V	3.3V	0V	0V
	61	62	63	64	65	66	67	68	69	70	61	62	63	64	65	66	67	68	69	70
	0.1V	1V	0V	0V	0.1V	0V	0.1V	0.1V	0.2V	0.2V	3.3V	-	3.3V	3.3V	3.3V	0V	3.3V	3.3V	3.3V	3.3V
	71	72	73	74	75	76	77	78	79	80	71	72	73	74	75	76	77	78	79	80
	0.1V	1V	0.2V	0.2V	0V	0.2V	0.2V	0.2V	0.1V	0V	3.3V	0V	0.9V	0.9V	0V	0.6V	1.3V	2.5V	3.3V	0V
81	82	83	84	85	86	87	88	89	90	81	82	83	84	85	86	87	88	89	90	
0V	0.2V	0.2V	0.2V	0V	0.2V	-	1.2V	1.1V	-	0V	0.8V	0.6V	1.1V	0V	0.7V	0.8V	0V	0V	0V	
91	92	93	94	95	96	97	98	99	100	91	92	93	94	95	96	97	98	99	100	
1.1V	0V	0.1V	0.4V	0.3V	0.3V	0V	0V	0.5V	-	0V	0V	3.3V	1.7V	1.7V	1.7V	0V	0V	2.5V	0V	
101	102	103	104	105	106	107	108	109	110	101	102	103	104	105	106	107	108	109	110	
0V	0.4V	1V	0.1V	0.2V	0.4V	0.2V	0V	0V	0V	0V	2.5V	1.7V	3.3V	1.6V	1.6V	0V	0V	0V	0V	
111	112	113	114	115	116	117	118	119	120	111	112	113	114	115	116	117	118	119	120	
-	0.2V	0V	0V	0.1V	0V	0.1V	0.1V	0V	0V	0V	0V	0V	0V	3.3V	0V	3.3V	3.3V	-	-	
121	122	123	124	125	126	127	128	129	130	121	122	123	124	125	126	127	128	129	130	
0V	0V	0V	0V	0V	0V	0.1V	0V	0V	0.1V	0V	-	0V	-	-	-	3.3V	-	-	1.6V	
131	132	133	134	135	136	137	138	139	140	131	132	133	134	135	136	137	138	139	140	
0V	0.1V	0.1V	0.1V	0.1V	0.1V	1V	1V	0V	1.1V	0V	0V	0V	0.2V	3.3V	0.2V	0.2V	0.2V	0V	0.2V	
141	142	143	144	145	146	147	148	149	150	141	142	143	144	145	146	147	148	149	150	
0.9V	1V	0.1V	0.9V	0.1V	0.1V	0V	0.1V	0.1V	0.1V	0.2V	0V	3.3V	0V	0V	0.2V	0V	3.1V	3V	3.1V	
151	152	153	154	155	156	157	158	159	160	151	152	153	154	155	156	157	158	159	160	
0.1V	0.1V	0.1V	0.1V	0V	0.1V	0V	0V	0.1V	0V	3.3V	3V	3.3V	0V	0V	3.3V	0V	0V	3.3V	0V	
IC130	1	2	3								1	2	3							
	0V	0.6V	0.1V								0V	5V	3.3V							
IC131	1	2	3	4	5	6	7	8	9	10	1	2	3	4	5	6	7	8	9	10
	0V	0.2V	0.6V	0V	0.2V	0.1V	0.1V	0.1V	0.1V	1.3V	1.6V	2.1V	5.1V	0V	1.3V	3.3V	3.3V	0V	3.3V	0V
	11	12	13	14	15	16	17	18	19	20	11	12	13	14	15	16	17	18	19	20
	0V	0V	0.6V	0V	0.3V	0.2V	0.2V	0.4V	0V	0.3V	2.5V	0V	5.1V	2.5V	2.5V	1.6V	0V	1.6V	0V	1V
	21	22	23	24							21	22	23	24						
	0.6V	0V	0V	0V							5.1V	0V	0V	0V						
IC132	1	2	3	4	5	6	7	8			1	2	3	4	5	6	7	8		
	0V	0V	0V	0V	0V	0V	0V	0V			6.5V	3.6V	3.5V	0V	3.5V	3.6V	6.6V	11.2V		
IC133	1	2	3	4	5						1	2	3	4	5					
	0.2V	0.2V	0V	0.2V	0.1V						2.2V	2.2V	0V	1.7V	3.3V					
IC134	1	2	3	4	5						1	2	3	4	5					
	0V	0V	0V	0V	0.6V						1.6V	1.6V	0V	2.4V	5V					
IC135	1	2	3	4	5						1	2	3	4	5					
	0.1V	0.1V	0V	0V	0.1V						1.6V	1.6V	0V	1.6V	3.3V					
IC136	1	2	3	4	5						1	2	3	4	5					
	0V	0V	0V	0.1V	0.1V						0V	*3	0V	1.6V	3.3V					
IC137	1	2	3	4	5						1	2	3	4	5					
	-	-	0V	-	0.1V						1.6V	1.6V	0V	1.6V	3.3V					

Pos.	Voltage indications: GDV120/02																			
	Power off										Power on									
IC101	1	2	3	4	5	6	7	8			1	2	3	4	5	6	7	8		
	0V	0V	0V	0V	3.3V	3.3V	0V	3.3V			0V	0V	0V	0V	3.3V	3.3V	0V	3.3V		
IC102	1	2	3	4	5	6	7	8	9	10	1	2	3	4	5	6	7	8	9	10
	3.3V	0V	0V	0V	3.3V	3.3V	3.3V	3.3V	3.3V	0V	3.3V	0.5V	0.4V	1.5V	3.3V	3.3V	3.3V	3.3V	3.3V	3.3V
	11	12	13	14	15	16	17	18	19	20	11	12	13	14	15	16	17	18	19	20
	3.3V	3.3V	3.3V	3.3V	0.3V	0.3V	3.3V	3.3V	0V	3.3V	3.3V	3.3V	3.3V	3.3V	3.3V	3.3V	2.5V	3.3V	0V	3.3V
	21	22	23	24	25	26	27	28	29	30	21	22	23	24	25	26	27	28	29	30
0V	0V	3.3V	3.3V	1.4V	0V	0V	3.3V	0V	3.3V	0V	3.3V	3.3V	3.3V	1.4V	1V	0.9V	3.3V	0V	3.3V	
IC103	1	2	3								1	2	3							
	4.9V	0V	2.5V								4.9V	0V	2.5V							
IC104	1	2	3								1	2	3							
	4.9V	0V	3.3V								4.9V	0V	3.3V							
IC105	1	2	3	4	5	6	7	8	9	10	1	2	3	4	5	6	7	8	9	10
	4.9V	0V	1.6V	4.9V	0V	4.9V	0V	4.9V	0V	4.9V	4.9V	0V	1.6V	4.9V	0V	4.9V	0V	4.9V	0V	4.9V
IC110	1	2	3	4	5	6	7	8	9	10	1	2	3	4	5	6	7	8	9	10
	3.3V	-	-	0V	0.4V	0.4V	3.3V	0.4V	0.4V	0V	3.3V	-	-	0V	-	-	3.3V	-	-	0V
	11	12	13	14	15	16	17	18	19	20	11	12	13	14	15	16	17	18	19	20
	0.4V	0.4V	3.3V	0V	3.3V	3.3V	3.3V	3.3V	0V	0V	-	-	3.3V	0V	3.3V	3V	3.1V	3.1V	0.2V	0V
	21	22	23	24	25	26	27	28	29	30	21	22	23	24	25	26	27	28	29	30
0V	0V	0V	0V	3.3V	0V	0V	0V	0V	0V	0V	0V	0.2V	0.2V	3.3V	0V	0.2V	0.2V	0.2V	0.2V	
IC111	1	2	3	4	5	6	7	8	9	10	1	2	3	4	5	6	7	8	9	10
	3.3V	-	-	0V	-	-	3.3V	-	-	0V	3.3V	-	-	0V	-	-	3.3V	-	-	0V
	11	12	13	14	15	16	17	18	19	20	11	12	13	14	15	16	17	18	19	20
	-	-	3.3V	0V	3.3V	3.3V	3.3V	3.3V	0V	0V	-	-	3.3V	0V	3.3V	3V	3.1V	3V	0.2V	0V
	21	22	23	24	25	26	27	28	29	30	21	22	23	24	25	26	27	28	29	30
0V	0V	0V	0V	3.3V	0V	0V	0V	0V	0V	0V	0V	0.2V	0.2V	3.3V	0V	0.2V	0.2V	0.2V	0.2V	
IC112	1	2	3	4	5	6	7	8	9	10	1	2	3	4	5	6	7	8	9	10
	0V	0.1V	3.3V	3.3V	0V	0.1V	3.3V	4.8V	0V	0V	0V	0.1V	3.3V	2.8V	3.3V	0.1V	3.3V	4.8V	0V	0V
IC113	1	2	3	4	5	6	7	8	9	10	1	2	3	4	5	6	7	8	9	10
	0V	0V	0V	0V	4.9V	0V	4.9V	0V	4.6V	0V	0V	0V	0V	0V	4.9V	0V	4.9V	0V	4.6V	0V
IC113	11	12	13	14	15	16	17	18	19	20	11	12	13	14	15	16	17	18	19	20
	3.2V	0V	3.2V	0V	3.3V	0V	0V	0V	0V	4.9V	3.2V	0V	3.3V	0V	3.3V	0V	0V	0V	0V	4.9V

Pos.	Voltage indications: GDV120/02																				
	Power off										Power on										
IC116	1	2	3	4	5	6	7	8	9	10	1	2	3	4	5	6	7	8	9	10	
	0V	2.5V	3.3V	0V	0V	0V	0V	0V	0V	0V	0V	2.5V	3.3V	0V	0V	0V	0V	0V	0V	0V	0V
	11	12	13	14	15	16	17	18	19	20	11	12	13	14	15	16	17	18	19	20	
	0V	3.3V	3.3V	3.3V	3.3V	3.3V	3.3V	3.3V	3.3V	0V	0V	3.3V	3.3V	3.3V	0V	3.3V *1	3.3V *2	3.3V	0V	3.3V	0V
	21	22	23	24	25	26	27	28	29	30	21	22	23	24	25	26	27	28	29	30	
	3.3V	0V	3.3V	3.3V	3.3V	0V	0V	3.3V	0V	0V	3.3V	0V	3.3V *2	3.3V	3.3V	0V	0V	3.3V	0V	0V	0V
	31	32	33	34	35	36	37	38	39	40	31	32	33	34	35	36	37	38	39	40	
	0V	0V	0V	0V	3.3V	3.3V	0V	3.3V	2.5V	0V	0V	0V	0V	0V	3.3V	3.3V	3.3V	3.3V	3.3V	2.5V	0V
	41	42	43	44	45	46	47	48	49	50	41	42	43	44	45	46	47	48	49	50	
	3.3V	0V	3.1V	0V	0.6V	3.1V	3.3V	2.7V	0V	0V	3.3V	0V	3.1V	0V	-	3.2V	3.3V	2.7V	0V	0V	0V
	51	52	53	54	55	56	57	58	59	60	51	52	53	54	55	56	57	58	59	60	
	0V	2.5V	2.5V	0V	1.6V	3.3V	0V	3.3V	3.3V	3.3V	0V	2.5V	2.5V	0V	1.6V	3.2V	3.3V	3.3V	3.3V	0V	0V
	61	62	63	64	65	66	67	68	69	70	61	62	63	64	65	66	67	68	69	70	
	0V	3.3V	3.3V	3.3V	0V	0V	0.5V	0V	0V	3.3V	0V	3.3V	3.3V	3.3V	0V	0V	3.3V	0V	0V	0V	0V
	71	72	73	74	75	76	77	78	79	80	71	72	73	74	75	76	77	78	79	80	
	3.3V	0V	0V	3.3V	3.3V	3.3V	3.3V	3.3V	3.3V	3.3V	3.3V	0V	0V	3.3V	3.1V	3.3V	3.3V	3.3V	3.2V	3.3V	0V
81	82	83	84	85	86	87	88	89	90	81	82	83	84	85	86	87	88	89	90		
0V	2.5V	0V	3.3V	0V	0V	0V	3.3V	3.3V	3.3V	0V	2.5V	3.3V	3.3V	0V	3.3V	0V	3.3V	3.3V	3.3V	0V	
91	92	93	94	95	96	97	98	99	100	91	92	93	94	95	96	97	98	99	100		
3.3V	3.3V	0V	3.3V	3.3V	0V	3.3V	0V	3.3V	0V	3.3V	0V	3.3V	3.2V	3.3V	0V	3.3V	0V	3.3V	0V	0V	
101	102	103	104	105	106	107	108	109	110	101	102	103	104	105	106	107	108	109	110		
3.3V	0.4V	0V	0.6V	0.5V	0.5V	0.6V	0.5V	0V	3.3V	2.7V	-	-	-	-	-	-	-	0V	3.3V	0V	
111	112	113	114	115	116	117	118	119	120	111	112	113	114	115	116	117	118	119	120		
0.5V	0V	3.3V	3.3V	3.3V	3.3V	3.3V	0V	0V	3.3V	-	0V	3.3V	3.3V	3.3V	3.3V	3.3V	0V	0V	0V	3.3V	
121	122	123	124	125	126	127	128	129	130	121	122	123	124	125	126	127	128	129	130		
0V	2.5V	1.6V	0V	-	-	-	-	-	0V	0V	2.5V	1.6V	0V	-	-	-	-	-	0V	0V	
131	132	133	134	135	136	137	138	139	140	131	132	133	134	135	136	137	138	139	140		
3.3V	-	-	0.6V	3.3V	3.3V	3.3V	3.3V	3.3V	0V	3.3V	-	-	1.1V	3.3V	3.3V	3.1V	3.1V	3.1V	0V	0V	
141	142	143	144	145	146	147	148	149	150	141	142	143	144	145	146	147	148	149	150		
3.3V	0.1V	3.3V	0V	0V	0V	0V	0V	0V	0V	3.3V	0V	3.2V	0V	0V	0V	0V	0V	0V	0V	0V	
151	152	153	154	155	156	157	158	159	160	151	152	153	154	155	156	157	158	159	160		
3.3V	0V	0V	0V	0V	0V	0V	0V	0V	3.3V	3.3V	0V	0V	0V	0V	0V	0V	0V	0V	0V	3.3V	
IC117	1	2	3	4	5	6	7	8	9	10	1	2	3	4	5	6	7	8	9	10	
	3.3V	-	-	0V	-	-	3.3V	-	0.3V	0V	3.3V	-	-	0V	-	-	3.3V	-	-	0V	
	11	12	13	14	15	16	17	18	19	20	11	12	13	14	15	16	17	18	19	20	
	0.3V	0.3V	3.3V	0V	2.1V	2.6V	2.5V	11.9V	0V	0V	-	-	3.3V	0V	3.3V	3.2V	3.3V	3.2V	0.2V	0.1V	0.1V
	21	22	23	24	25	26	27	28	29	30	21	22	23	24	25	26	27	28	29	30	
2.3V	2.4V	0.8V	1.7V	3.3V	0V	3.2V	1.7V	1.5V	3.1V	3.1V	3.2V	3.1V	0V	3.3V	0V	0V	0.2V	3.3V	0V	0V	
31	32	33	34	35	36	37	38	39	40	31	32	33	34	35	36	37	38	39	40		
1.8V	0V	0V	3.3V	1.6V	0V	0V	3.3V	-	-	0V	0V	0V	3.3V	1.6V	0V	0V	3.3V	-	-	-	
41	42	43	44	45	46	47	48	49	50	41	42	43	44	45	46	47	48	49	50		
0V	-	-	3.3V	-	-	0V	-	-	0V	0V	-	-	3.3V	-	-	0V	-	-	0V	0V	
IC118	1	2	3	4	5	6	7	8	9	10	1	2	3	4	5	6	7	8	9	10	
	0V	-	0V	0V	0.1V	3.2V	0V	-	3.3V	0V	0.1V	-	0.1V	0.1V	0.1V	3.1V	0.1V	-	3.3V	0.1V	
	11	12	13	14	15	16	17	18	19	20	11	12	13	14	15	16	17	18	19	20	
	0V	0V	0V	0V	0V	0V	0V	-	3.1V	3.2V	0V	0.1V	0.1V	3.3V	0.1V	0V	0V	0V	0V	3.3V	
	21	22	23	24	25	26	27	28	29	30	21	22	23	24	25	26	27	28	29	30	
0.1V	0.1V	0V	0.1V	0V	0.1V	0V	0V	-	-	0V	0.1V	0V	3.3V	3.3V	3.3V	0V	3.2V	-	-	-	
31	32	33	34	35	36	37	38	39	40	31	32	33	34	35	36	37	38	39	40		
-	-	-	-	-	-	3.3V	0V	-	-	-	-	-	-	-	-	3.3V	0V	-	-	-	
41	42	43	44	45	46	47	48			41	42	43	44	45	46	47	48				
-	-	-	-	-	-	0V	0V			-	-	-	-	-	-	0V	0.1V				

Pos.	Voltage indications: GDV120/02																									
	Power off										Power on															
IC127	1	2	3	4	5	6	7	8	9	10	1	2	3	4	5	6	7	8	9	10						
	0V	-	-	-	-	3.3V	-	-	-	-	0V	-	-	-	-	3.3V	-	-	-	-						
	11	12	13	14	15	16	17	18	19	20	11	12	13	14	15	16	17	18	19	20						
	0V	3.3V	3.3V	3.3V	3.3V	3.3V	3.3V	3.3V	3.3V	0V	0V	3.3V	0V	3.3V	0V	3.3V	0V	0V	3.3V	0V						
	21	22	23	24	25	26	27	28	29	30	21	22	23	24	25	26	27	28	29	30						
	3.3V	0V	0V	3.3V	3.3V	3.3V	3.3V	0V	3.3V	3.3V	3.3V	0V	0V	3.3V	3.3V	3.3V	3.3V	0V	3.3V	0V						
	31	32	33	34	35	36	37	38	39	40	31	32	33	34	35	36	37	38	39	40						
	0V	0V	0V	-	3.1V	3.2V	0.1V	3.2V	3.2V	3.3V	0V	0V	0V	0V	3.3V	0V	3.3V	0V	0V	3.3V						
	41	42	43	44	45	46	47	48	49	50	41	42	43	44	45	46	47	48	49	50						
	0.1V	3.3V	3.3V	3.3V	3.3V	0V	-	-	-	-	0V	3.3V	3.3V	3.1V	3V	0V	-	-	-	-						
	51	52	53	54	55	56	57	58	59	60	51	52	53	54	55	56	57	58	59	60						
	-	-	-	-	0V	1.7V	0V	3.3V	0V	0V	-	-	-	-	0V	1.6V	3.3V	3.3V	0V	0V						
	61	62	63	64	65	66	67	68	69	70	61	62	63	64	65	66	67	68	69	70						
	3.3V	-	0V	3.3V	3.3V	0V	3.3V	3.3V	0.6V	0.7V	3.3V	-	3.2V	3.3V	3.3V	0V	3.3V	3.3V	3.3V	3.3V						
	71	72	73	74	75	76	77	78	79	80	71	72	73	74	75	76	77	78	79	80						
	3.3V	0V	0V	0V	0V	0V	0V	0V	3.3V	0V	3.3V	0V	0.5V	0.5V	0V	0.5V	0.5V	1.7V	3.3V	0V						
81	82	83	84	85	86	87	88	89	90	81	82	83	84	85	86	87	88	89	90							
0V	0V	0V	0V	0V	0V	3.3V	0V	0V	0V	0V	0.5V	0.4V	1.5V	0V	0.7V	0.8V	0V	0V	0V							
91	92	93	94	95	96	97	98	99	100	91	92	93	94	95	96	97	98	99	100							
0V	0V	3.3V	3.3V	3.3V	3.3V	0V	1.1V	1.6V	0V	0V	0V	3.3V	1.7V	17V	1.7V	0V	1.1V	1.6V	0V							
101	102	103	104	105	106	107	108	109	110	101	102	103	104	105	106	107	108	109	110							
0V	1.6V	0V	3.3V	0V	0V	0V	0V	0V	0V	0V	1.6V	1.7V	3.3V	1.6V	1.6V	0V	0V	0V	0V							
111	112	113	114	115	116	117	118	119	120	111	112	113	114	115	116	117	118	119	120							
0V	0V	0V	0V	3.3V	0V	3.3V	3.3V	-	-	1.6V	0V	0V	0V	3.3V	0V	3.3V	3.3V	-	-							
121	122	123	124	125	126	127	128	129	130	121	122	123	124	125	126	127	128	129	130							
0V	-	0V	-	-	-	3.3V	-	-	1.6V	0V	-	0V	-	-	-	3.3V	-	-	1.6V							
131	132	133	134	135	136	137	138	139	140	131	132	133	134	135	136	137	138	139	140							
0V	0V	0V	0V	3.3V	0V	0V	0V	0V	0V	0V	0V	0V	0,2	3.3V	0.2V	0.2V	0.2V	0V	0.2V							
141	142	143	144	145	146	147	148	149	150	141	142	143	144	145	146	147	148	149	150							
0V	0V	3.3V	0V	0V	0V	0V	3.3V	3.3V	3.3V	0.2V	0V	3.3V	0V	0V	0.2V	0V	3.1V	3V	3.1V							
151	152	153	154	155	156	157	158	159	160	151	152	153	154	155	156	157	158	159	160							
3.3V	3.3V	3.3V	0V	0V	3.3V	0V	0V	3.3V	0V	3.3V	3V	3.3V	0V	0V	3.3V	0V	0V	3.3V	0V							
IC130	1	2	3													1	2	3								
	0V	4.9V	3.3V													0V	4.9V	3.3V								
IC131	1	2	3	4	5	6	7	8	9	10	1	2	3	4	5	6	7	8	9	10						
	1.6V	5V	5V	0V	1V	3.3V	3.3V	3.3V	0V	0V	1.7V	2.1V	5V	0V	1V	3.3V	3.3V	0V	3.3V	0V						
	11	12	13	14	15	16	17	18	19	20	11	12	13	14	15	16	17	18	19	20						
2.5V	0V	5V	2.5V	2.5V	0V	0V	0V	0V	1V	2.5V	0V	5V	2.5V	2.5V	1.6V	0V	1.6V	0V	0.8V							
21	22	23	24													21	22	23	24							
	5V	0V	0V	0V													5V	0V	0V	0V						
IC132	1	2	3	4	5	6	7	8			1	2	3	4	5	6	7	8								
	6.6V	3.6V	3.5V	0V	3.5V	3.6V	6.6V	11.1V			6.6V	3.6V	3.5V	0V	3.5V	3.6V	6.6V	11.1V								
IC133	1	2	3	4	5											1	2	3	4	5						
	5V	5V	0V	3.3V	3.3V											2.2V	2.2V	0V	1.7V	3.3V						
IC135	1	2	3	4	5											1	2	3	4	5						
	2.4V	2.4V	0V	1.6V	3.3V											2.4V	2.4V	0V	1.6V	3.3V						
IC136	1	2	3	4	5											1	2	3	4	5						
		0V	0V	2.5V	3.3V												*3	0V	2.5V	3.3V						
IC137	1	2	3	4	5											1	2	3	4	5						
	0V	0V	0V	0V	3.3V											1.6V	1.6V	0V	1.6V	3.3V						

Remark: *1 Depend on PAL NTSC SW setting
 *2 Depend on sales destination
 *3 Clock input

Pos.	Voltage indications																				
	Power off										Power on										
IC480	1 0V	2 0V	3 0.6V	4 0.6V	5 5.5V						1 0V	2 2.5V	3 5.1V	4 5.1V	5 5.3V						
IC483	1 2.5V	2 0V	3 4V								1 2.5V	2 0V	3 4.2V								
IC601	1 4.9V	2 0V	3 2.7V	4 3V	5 0V	6 4.9V	7 1.2V	8 1.2V	9 2V	10 0V	1 4.7V	2 0V	3 2.5V	4 2.9V	5 0V	6 4.6V	7 5V	8 0.1V	9 4.9V	10 0V	
	11 0V	12 0V	13 4.9V	14 4.9V	15 1.6V	16 1.6V	17 0V	18 0V	19 0V	20 0V	11 0V	12 0V	13 4.7V	14 4.7V	15 4.9V	16 4.9V	17 4V	18 0V	19 0V	20 0V	
	21 0V	22 0V	23 0V	24 4.9V	25 4.9V	26 0V	27 0V	28 0V	29 0V	30 0V	21 -0.1V	22 0V	23 0V	24 4.7V	25 4.7V	26 0.1V	27 0V	28 0V	29 0V	30 0V	
	31 -0.1V	32 0V	33 0V	34 0V	35 0V	36 0V	37 0V	38 0V	39 0.1V	40 0V	31 0V	32 0V	33 0V	34 0V	35 0V	36 0V	37 0V	38 0V	39 4.6V	40 -0.6V	
	41 0V	42 0V	43 0V	44 4.9V	45 4.9V	46 0V	47 -26.4V	48 -26.4V	49 -26.7V	50 -26.5V	41 -0.2V	42 0V	43 0V	44 0V	45 4.7V	46 4.6V	47 -27.9V	48 -28V	49 -27.8V	50 -28V	
	51 -26.5V	52 -26.3V	53 -26.3V	54 -26.5V	55 -25.7V	56 -23V	57 -24.2V	58 -25.2V	59 4.9V	60 0V	51 -27.7V	52 -22.4V	53 -23V	54 -20.3V	55 -18.3V	56 -13.2V	57 -13.9V	58 -22.9V	59 4.7V	60 -28.2V	
	61 -24.9V	62 -25.6V	63 -25.2V	64 -25.4V	65 -25.3V	66 -25V	67 -25.2V	68 -25.1V	69 -22.9V	70 -21.4V	61 -26.6V	62 -17.2V	63 -25.5V	64 -14.9V	65 -17.5V	66 -24.9V	67 -22V	68 -24.1V	69 -24.8V	70 -23.9V	
	71 -22.9V	72 -21.4V	73 -22.4V	74 -22.4V	75 -22.9V	76 -22.5V	77 -22.8V	78 -22.9V	79 -20.4V	80 -22.7V	71 -23.8V	72 -22.9V	73 -22.8V	74 -24V	75 -23.9V	76 -23.8V	77 -24.4V	78 -24V	79 -23.9V	80 -25.6V	
IC602	1 4.9V	2 0V	3 4.9V								1 4.7V	2 0V	3 4.7V								
IC673	1 0.5	2 0V	3 0V	4 0V	5 0.1V	6 0.3V	7 0.1V	8 0.1V	9 0.1V	10 0.1V	1 -4.3V	2 0V	3 0V	4 0V	5 4.5V	6 4.5V	7 4.5V	8 4.5V	9 4.5V	10 4.5V	
	11 0V	12 0.1V	13 0.1V	14 0.1V	15 0.1V	16 0.1V					11 8.8V	12 0.8V	13 4.5V	14 4.5V	15 4.5V	16 4.5V					
IC674	1 0.1V	2 0.1V	3 0V	4 0V	5 0V	6 0.2V	7 0.2V	8 0V			1 5.6V	2 5.6V	3 5.6V	4 0V	5 5.6V	6 5.6V	7 5.6V	8 11.2V			

Pos.	Voltage indications					
	Power off			Power on		
	E	C	B	E	C	B
Q4801	-26.6V	-27.2V	-27.2V	-27.8V	-31V	-28.5V
Q4820	0V	21.5V	0.1V	11.2V	23.4V	11.8V
Q4850	0V	4.9V	0.1V	0V	0.8V	4.6V
Q4851	0V	0V	4.9V	0V	2.5V	0.1V
Q4852	0V	4.9V	0.1V	0V	0.1V	4.6V
Q4853	0V	0V	-0.7V	0V	-24V	1.5V
Q4854	-23.4V	-15V	-22.9V	-24.3V	-23.5V	-23.6V
Q4855	-15.1V	-22.9V	-11.7V	-23.5V	-23.6V	-24.1V
Q4856	0V	0.1V	4.9V	0V	11.8V	0.1V
Q6021	15.9V	0V	0.1V	4.6V	0V	4.6V
Q6022	0V	4.4V	0.1V	0V	0.1V	0V
Q6023	0V	3.6V	0V	0V	3.4V	0V
Q6030	0V	0V	0.7V	0V	0V	0.6V
Q6031	0V	0.6V	0V	0V	5.1V	0V
Q6701	0V	0V	0V	0V	0V	0.7V
Q6733	0V	0.1V	0.1V	2.7V	3.3V	3.3V
Q6801	0V	0V	0.7V	0V	0V	0.7V
GDV120						
Q8003	4.9V	4.8V	1.3V	4.7V	4.6V	0V
Q8004	0V	1.3V	0.1V	0V	0V	0V
Q8006	0V	0.5V	0V	0V	4.3V	0V
GDV120/02						
Q8003	4.9V	4.9V	0V	4.9V	4.9V	0V
Q8004	0V	0V	3.3V	0V	0V	0V
Q8006	0V	4.9V	0V	0V	4.9V	0V

Explosionszeichnungen und Ersatzteillisten

Exploded Views and Spare Parts Lists

1

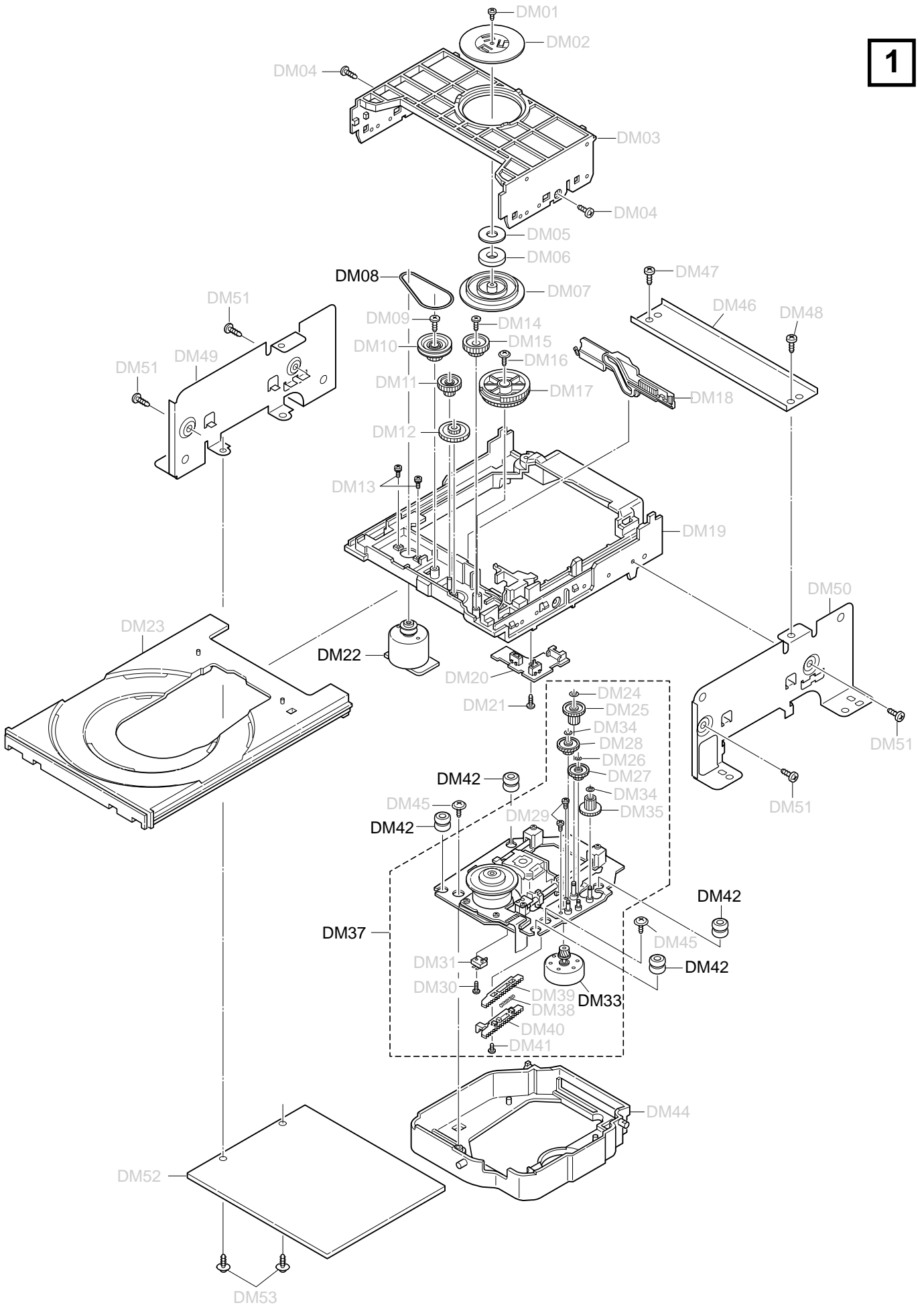

2

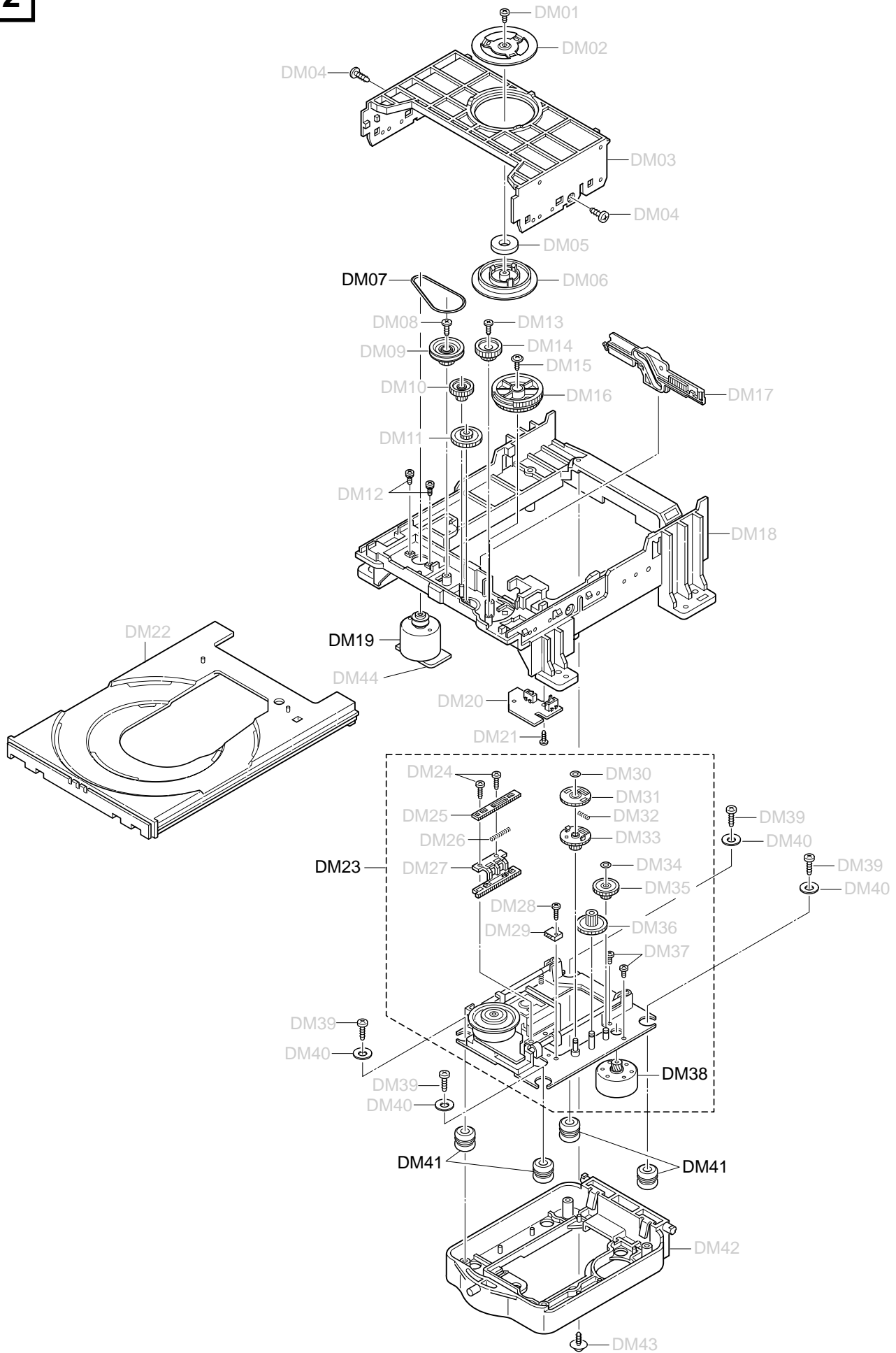

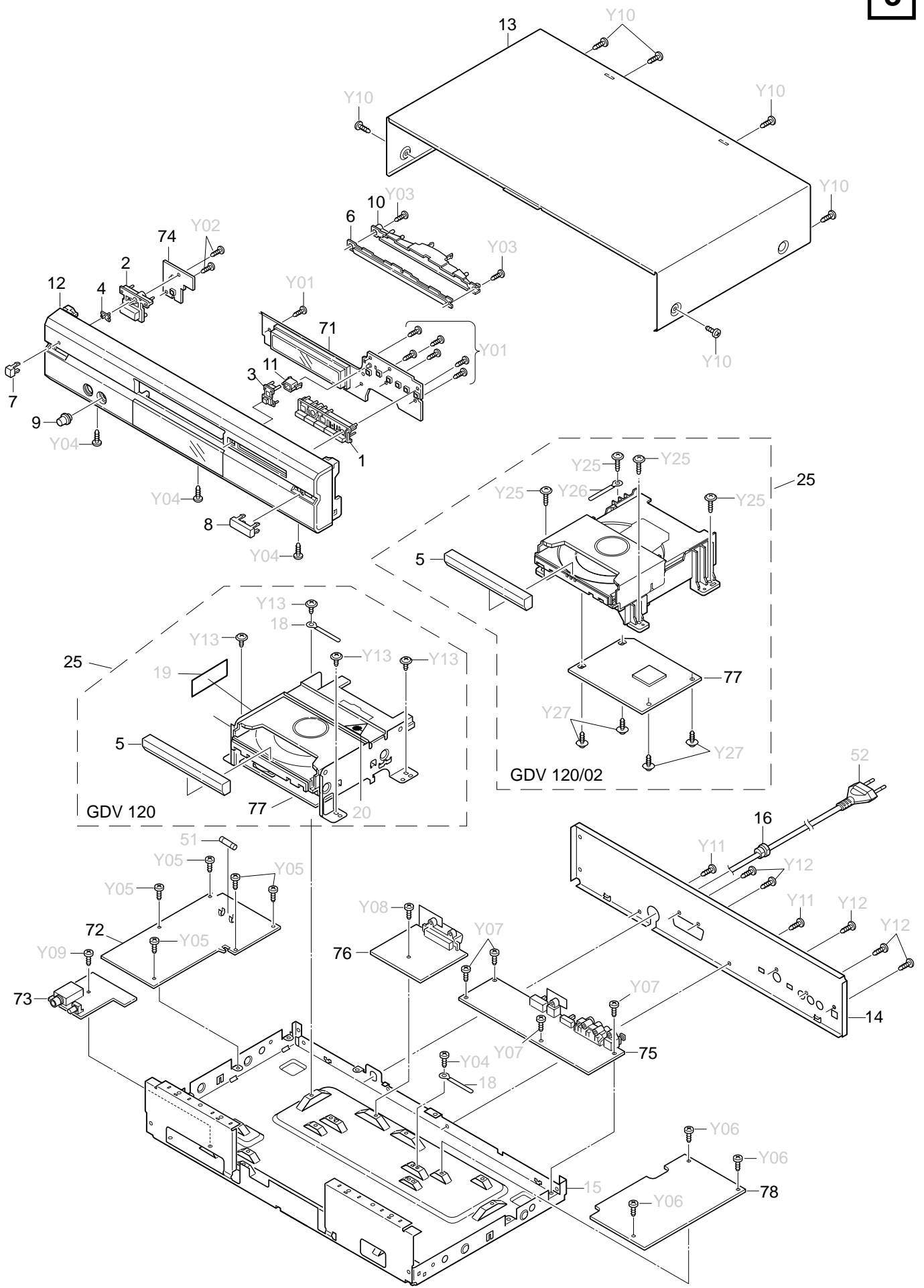

Ersatzteilliste
Spare Parts List

7 / 2000

DVD

GDV 120
GDV 120/02 *MATERIAL-NR. / PART NO.: 75868 710 0000
BESTELL-NR. / ORDER NO.: GM15000

POS. NR. POS. NO.	ABB. FIG.	MATERIAL-NR. PART NUMBER	ANZ. QTY.	BEZEICHNUNG (D)	DESCRIPTION (GB)
		75868 710 0000		GDV 120 / GDV 120/02 * KEIN E-TEIL	GDV 120 / GDV 120/02 * NO SPARE PART
0001.000	3	75988 065 0100		KNOPF, PLAY/PAUSE/STOP	KNOB, PLAY/PAUSE/STOP
0002.000	3	75988 065 0200		KNOPF POWER	KNOB POWER
0003.000	3	75988 065 0300		KNOPF, OPEN/CLOSE	KNOB, OPEN/CLOSE
0003.000	3	75988 067 1000		KNOPF, OPEN/CLOSE	KNOB, OPEN/CLOSE
0004.000	3	75988 065 0400		ABDECKUNG LED-FENSTER	LID LED WINDOW
0005.000	3	75988 065 0500		SCHUBLADE	TRAY
0006.000	3	75988 065 0600		FENSTER SCHUBLADE	WINDOW TRAY
0007.000	3	75988 065 0700		BLLENDE LINKS	DEC LEFT
0008.000	3	75988 065 0800		BLLENDE RECHTS	DEC RIGHT
0009.000	3	75988 065 0900		KNOPF VOLUMEN	KNOB VOLUME
0010.000	3	75988 065 1000		REFLEKTOR, SCHUBLADE	REFLECTOR, TRAY
0011.000	3	75988 065 1100		REFLEKTOR, OPEN/CLOSE	REFLECTOR, OPEN/CLOSE
0012.000	3	75988 065 1200		FRONTPLATTE	FRONT PANEL
0013.000	3	75988 065 1300		DECKEL	CABINET UPPER PART
0014.000	3	75988 065 1400		RUECKTEIL	REAR CASE
0014.000	3	75988 067 1100		RUECKTEIL	REAR CASE
0016.000	3	75988 065 1500		ZUGENTLASTUNG	FIXING
0021.000		75988 065 0000		FERNBEDIENUNG TP82V	REMOTE CONTROL TP82V
0025.000 [△] 1		75988 067 0000	X	LAUFWERK KPL. (KIT150)	TAPE DRIVE CPL. (KIT150)
0025.000 [△] 2		75988 069 0000	X*	LAUFWERK KPL. (KIT300)	TAPE DRIVE CPL. (KIT300)
0071.000	3	27599 002 9200	X	LP-BEDIEN MODUL KEIN E-TEIL	CONTROLBOARD C.B.A NO SPARE PART
0072.000 [△] 1		27599 003 2100	X	LP-NETZTEIL MODUL	POWER SUPPLY BOARD C.B.A
0073.000	3	75988 065 6700		LP-KOPFHOERER MODUL	HEADPHONE C.B.A
0074.000	3	75988 065 7400		LP-NETZSCHALTER MODUL	POWER SWITCH C.B.A
0075.000	3	27599 002 9300		LP-SOCKET BUCHSEN MODUL	SOCKETBOARD C.B.A
0076.000	3	75988 065 8600		LP-EURO-AV	EURO-AV C.B.A
0077.000	3	27599 006 0900		LP-LAUFWERK MODUL (KIT150)	TAPE DRIVE C.B.A (KIT150)
0077.000	3	27599 006 1000		LP-LAUFWERK MODUL (KIT300)	TAPE DRIVE C.B.A (KIT300)
0078.000	3	27599 009 0600		LP-MPEG-MODUL (KIT150)	MPEGBOARD C.B.A (KIT150)
0078.000	3	27599 009 0700		LP-MPEG-MODUL (KIT300)	MPEGBOARD C.B.A (KIT300)
		72010 539 4000		BEDIENUNGSANLEITUNG D/GB	INSTRUCTION MANUAL D/GB
		72010 539 4100		BEDIENUNGSANLEITUNG F/NL	INSTRUCTION MANUAL F/NL
		72010 539 4200		BEDIENUNGSANLEITUNG S/DK	INSTRUCTION MANUAL S/DK
		72010 539 4300		BEDIENUNGSANLEITUNG N/FIN	INSTRUCTION MANUAL N/FIN
		72010 539 4400		BEDIENUNGSANLEITUNG E/P	INSTRUCTION MANUAL E/P
		72010 539 3500		SERVICE MANUAL D/GB	SERVICE MANUAL D/GB
CN 00001		75988 065 1600		FLEXIBLE LEITUNG 20P MPEG-LOADER	FLEXIBLE CABLE 20P MPEG-LOADER
CN 00002		75988 065 1700		FLEXIBLE LEITUNG 28P MPEG-LOADER	FLEXIBLE CABLE 28P MPEG-LOADER
CN 00004		75988 065 1800		FLEXIBLE LEITUNG 10P FRONT-MPE 6	FLEXIBLE CABLE 10P FRONT-MPE 6
CN 00005		75988 065 1900		FLEXIBLE LEITUNG 6P MPEG-LOADER	FLEXIBLE CABLE 6P MPEG-LOADER
CN 00006		75988 065 2000		FLEXIBLE LEITUNG 10P MPEG-DG	FLEXIBLE CABLE 10P MPEG-DG
CN 00007		75988 065 2100		FLEXIBLE LEITUNG 10P MPEG-SOCKEL	FLEXIBLE CABLE 10P MPEG-SOCKET
CN 00008		75988 065 2200		FLEXIBLE LEITUNG 8P MPEG-SOCKEL	FLEXIBLE CABLE 8P MPEG-SOCKET
CN 00009		75988 065 2300		FLEXIBLE LEITUNG 11P SOCKEL-SCART	FLEXIBLE CABLE 11P SOCKET-SCART
CN 00010		75988 065 2400		FLEXIBLE LEITUNG 5P SOCKEL-H.P	FLEXIBLE CABLE 5P SOCKET-H.P

X = SIEHE GESONDERTE E-LISTE

X = SEE SEPARATE PARTS LIST

Es gelten die Vorschriften und Sicherheitshinweise gemäß dem Service Manual "Sicherheit", Mat.-Nummer 72010 800 0000, sowie zusätzlich die eventuell abweichenden, landesspezifischen Vorschriften!



The regulations and safety instructions shall be valid as provided by the "Safety" Service Manual, part number 72010 800 0000, as well as the respective national deviations.

ÄNDERUNGEN VORBEHALTEN / SUBJECT TO ALTERATION

Ersatzteilliste
Spare Parts List

7 / 2000

DVD

LAUFWERK (KIT150)
TAPE DRIVE (KIT150)

MATERIAL-NR. / PART NO.: 75988 067 0000

POS. NR. POS. NO.	ABB. FIG.	MATERIAL-NR. PART NUMBER	ANZ. QTY.	BEZEICHNUNG (D)	DESCRIPTION (GB)
		75988 067 0000		LAUFWERK KPL. (KIT150)	TAPE DRIVE CPL. (KIT150)
DM 00008	1	75988 066 5400		RIEMEN	BELT
DM 00020	1	75988 066 8900		LP-SCHALTER MODUL	SWITCH BOARD C.B.A.
DM 00022	1	75988 066 6900		LADEMOTOR	LOADING MOTOR
DM 00033	1	75988 066 8600		SLEDGEMOTOR	SLEDGEMOTOR
DM 00037	1	75988 066 7900		MECHANIK + LASEREINHEIT	MECHANISM AND LASERUNIT
DM 00042	1	75988 066 8300	4	DAEMPfung	DAMPING

7 / 2000

LAUFWERK (KIT300)
TAPE DRIVE (KIT300)

MATERIAL-NR. / PART NO.: 75988 069 0000

POS. NR. POS. NO.	ABB. FIG.	MATERIAL-NR. PART NUMBER	ANZ. QTY.	BEZEICHNUNG (D)	DESCRIPTION (GB)
		75988 069 0000		LAUFWERK KPL. (KIT300)	TAPE DRIVE CPL. (KIT300)
DM 00007	2	75988 066 5400		RIEMEN	BELT
DM 00019	2	75988 066 6900		LADEMOTOR	LOADING MOTOR
DM 00020	2	75988 067 1700		LP-SCHALTER MODUL	SWITCH BOARD C.B.A.
DM 00023	2	75988 067 0800		MECHANIK + LASEREINHEIT	MECHANISM AND LASERUNIT
DM 00038	2	75988 067 0600		SLEDGEMOTOR	SLEDGEMOTOR
DM 00041	2	75988 067 1200	4	DAEMPfung	DAMPING

Es gelten die Vorschriften und Sicherheitshinweise gemäß dem Service Manual "Sicherheit", Mat.-Nummer 72010 800 0000, sowie zusätzlich die eventuell abweichenden, landesspezifischen Vorschriften!











































The regulations and safety instructions shall be valid as provided by the "Safety" Service Manual, part number 72010 800 0000, as well as the respective national deviations.

ÄNDERUNGEN VORBEHALTEN / SUBJECT TO ALTERATION

GRUNDIGErsatzteilliste
Spare Parts List**DVD****7 / 2000****LP-NETZTEIL MODUL
POWER SUPPLY BOARD C.B.A**

MATERIAL-NR. / PART NO.: 27599 003 2100

POS. NR. POS. NO.	ABB. FIG.	MATERIAL-NR. PART NUMBER	ANZ. QTY.	BEZEICHNUNG 	DESCRIPTION 
		27599 003 2100		LP NETZTEIL MODUL	POWER SUPPLY BOARD C.B.A

POS. NR. POS. NO.	MATERIAL-NR. PART NUMBER	BEZEICHNUNG DESCRIPTION	POS. NR. POS. NO.	MATERIAL-NR. PART NUMBER	BEZEICHNUNG DESCRIPTION
B 04801	75988 066 9000	SPULE 1000 OHM	PC 00491 	75988 065 4400	OPTOKOPPLER TLP621-GR
C 04851	75988 065 7600	KERAMIK KONDENS.1U S	PR 00481 	75988 065 6100	SI.-WIDERST. 0.25A 125V
C 04852	75988 065 7600	KERAMIK KONDENS.1U S	PR 00482 	75988 065 6200	SI.-WIDERST. 1A 125V
C 04900		75988 065 4700 MT 0.022 U K 400V	PR 00483 	75988 065 6300	SI.-WIDERST. 0.5A 125V
C 04904		75988 065 4800 KERKO 220P K 1K	PT 00490 	75988 066 9100	TRANS NETZ
C 04906		75988 065 4900 MT 0.1UF K 250V	Q 04801	75988 065 9200	TRANS KTA 1271-Y
C 04907		75988 065 4900 MT 0.1UF K 250V	Q 04820		75988 066 9300 TRANS KTD 863-GR
C 04908		75988 065 5000 KERKO 2200P M 400V	Q 04850	75988 066 9400	TRANS KRC104M
D 04800	75988 065 4100	Z-DIODE MTZJ30B	Q 04851	75988 066 9400	TRANS KRC104M
D 04802		75988 065 4200 DIODE AG01Z	Q 04853	75988 066 9500	TRANS KTA1267-GR
D 04803		75988 065 4300 DIODE RK36LF-C4	Q 04854		75988 066 9300 TRANS KTD 863-GR
D 04804		75988 067 0100 DIODE RK34LF-C4	Q 04855	75988 066 9500	TRANS KTA1267-GR
D 04805		75988 065 4200 DIODE AG01Z	Q 04856	75988 066 9400	TRANS KRC104M
D 04806		75988 065 4200 DIODE AG01Z	R 04901		75988 066 9600 WIDERST 220K J- 1W
D 04807	75988 065 4500	Z-DIODE MTZJ3.6B	R 04905		75988 065 6400 WIDERST. 0.56 J- 1W
D 04820	75988 065 4600	Z-DIODE MTZJ12B	R 04907		75988 066 9600 WIDERST 220K J- 1W
D 04850		75988 067 1500 DIODE DSK10C	R 04908		75988 065 6600 WIDERST. 3.3M J- 1/2W
D 04900		75988 065 5200 DIODE AP01C			
D 04901		75988 065 4200 DIODE AG01Z			
D 04902		75988 065 4200 DIODE AG01Z			
D 04903		75988 065 4200 DIODE AG01Z			
D 04904		75954 042 0500 DIODE 1N4004			
D 04905		75954 042 0500 DIODE 1N4004			
D 04906		75954 042 0500 DIODE 1N4004			
D 04907		75954 042 0500 DIODE 1N4004			
FPC0001	75988 065 5100	SICHERUNGSHALTER			
FU 490		83156 170 0400 SI 5X20 T1A L250V			
HS 00491 	75988 065 5300	SICHERUNGSSCHEIBE			
IC 00480		75988 065 5400 IC SI-3050C			
IC 00483		75988 065 5500 IC LS431			
IC 00490		75988 065 5600 IC STR-G6651			
L 04800	75988 067 1600	SPULE 22UH			
L 04801	75988 065 5700	SPULE 22UH K			
L 04802	75988 065 5800	SPULE 100UH J			
L 04900		75988 065 5900 FILTER			
PC 00490 	75988 065 4400	OPTOKOPPLER TLP621-GR			

Es gelten die Vorschriften und Sicherheitshinweise gemäß dem Service Manual "Sicherheit", Mat.-Nummer 72010 800 0000, sowie zusätzlich die eventuell abweichenden, landesspezifischen Vorschriften!





The regulations and safety instructions shall be valid as provided by the "Safety" Service Manual, part number 72010 800 0000, as well as the respective national deviations.

ÄNDERUNGEN VORBEHALTEN / SUBJECT TO ALTERATION

GRUNDIGErsatzteilliste
Spare Parts List**DVD****7 / 2000****LP BEDIEN MODUL
CONTROLBOARD C.B.A**

MATERIAL-NR. / PART NO.: 27599 002 9200

POS. NR. POS. NO.	ABB. FIG.	MATERIAL-NR. PART NUMBER	ANZ. QTY.	BEZEICHNUNG 	DESCRIPTION 
		27599 002 9200		LP BEDIEN MODUL KEIN E-TEIL	CONTROLBOARD C.B.A NO SPARE PART

POS. NR. POS. NO.	MATERIAL-NR. PART NUMBER	BEZEICHNUNG DESCRIPTION	POS. NR. POS. NO.	MATERIAL-NR. PART NUMBER	BEZEICHNUNG DESCRIPTION
CN 00602	75988 065 2500	SOCKEL 6P	D 06022	75988 065 2800	LED SLP-3118B-51HAB-T1
CN 00604	75988 065 2600	SOCKEL 4P	D 06023	75988 065 2900	LED SLP-9118C-51H-S-T1
CN 00612	75988 065 2700	LEITUNG, FRONT-DG	D 06040	75954 035 6900	DIODE 1SS133
D 06022	75988 065 2800	LED SLP-3118B-51HAB-T1	D 06041	75954 035 6900	DIODE 1SS133
D 06023	75988 065 2900	LED SLP-9118C-51H-S-T1	D 06042	75954 035 6900	DIODE 1SS133
D 06040	75954 035 6900	DIODE 1SS133	D 06043	75954 035 6900	DIODE 1SS133
D 06041	75954 035 6900	DIODE 1SS133	D 06044	75954 035 6900	DIODE 1SS133
D 06042	75954 035 6900	DIODE 1SS133	D 06045	75954 035 6900	DIODE 1SS133
D 06043	75954 035 6900	DIODE 1SS133	DS 00601	75988 065 3000	FOTODIODE 440-1-G
D 06044	75954 035 6900	DIODE 1SS133	FL 00601	75988 065 3100	FLOURESZENTROEHRE
D 06045	75954 035 6900	DIODE 1SS133	IC 00601	75988 065 3200	IC 16316-80-003 (GDV120)
DS 00601	75988 065 3000	FOTODIODE 440-1-G	IC 00601	75988 067 1300	IC UPD780232GC-017-8BT (GDV120/02)
FL 00601	75988 065 3100	FLOURESZENTROEHRE	IC 00602	75988 065 3300	IC BMR-0301E
IC 00601	75988 065 3200	IC 16316-80-003 (GDV120)	Q 06021	75952 011 5500	SMD TRANS. DTA 114 EK
IC 00601	75988 067 1300	IC UPD780232GC-017-8BT (GDV120/02)	Q 06022	75988 065 3400	TRANS DTC114YK
IC 00602	75988 065 3300	IC BMR-0301E	Q 06023	75952 011 5500	SMD TRANS. DTA 114 EK
Q 06021	75952 011 5500	SMD TRANS. DTA 114 EK	Q 06030	75988 065 3500	TRANS 2SC2412K-R
Q 06022	75988 065 3400	TRANS DTC114YK	Q 06031	75988 060 5900	TRANS DTC124EK-T-96
Q 06023	75952 011 5500	SMD TRANS. DTA 114 EK	Q 06041	75988 011 5500	EPROM 470 C
Q 06030	75988 065 3500	TRANS 2SC2412K-R	Q 06042	75988 065 3600	TRANS 2SA1037K-R
Q 06031	75988 060 5900	TRANS DTC124EK-T-96	Q 06043	75988 067 1400	TRANS KRA104S
Q 06041	75988 011 5500	EPROM 470 C	S 06040	75988 065 3700	SCHALTER 1P-1T
Q 06042	75988 065 3600	TRANS 2SA1037K-R	S 06041	75988 065 3700	SCHALTER 1P-1T
Q 06043	75988 067 1400	TRANS KRA104S	S 06042	75988 065 3700	SCHALTER 1P-1T
S 06040	75988 065 3700	SCHALTER 1P-1T	S 06043	75988 065 3700	SCHALTER 1P-1T
S 06041	75988 065 3700	SCHALTER 1P-1T	S 06044	75988 065 3700	SCHALTER 1P-1T
S 06042	75988 065 3700	SCHALTER 1P-1T	S 06045	75988 065 3700	SCHALTER 1P-1T
S 06043	75988 065 3700	SCHALTER 1P-1T	X 06001	75988 065 3900	QUARZ KERAMIC 5.000MHZ
S 06044	75988 065 3700	SCHALTER 1P-1T			
S 06045	75988 065 3700	SCHALTER 1P-1T			

Es gelten die Vorschriften und Sicherheitshinweise gemäß dem Service Manual "Sicherheit", Mat.-Nummer 72010 800 0000, sowie zusätzlich die eventuell abweichenden, landesspezifischen Vorschriften!



The regulations and safety instructions shall be valid as provided by the "Safety" Service Manual, part number 72010 800 0000, as well as the respective national deviations.

ÄNDERUNGEN VORBEHALTEN / SUBJECT TO ALTERATION

GRUNDIG

Kundendienst Deutschland

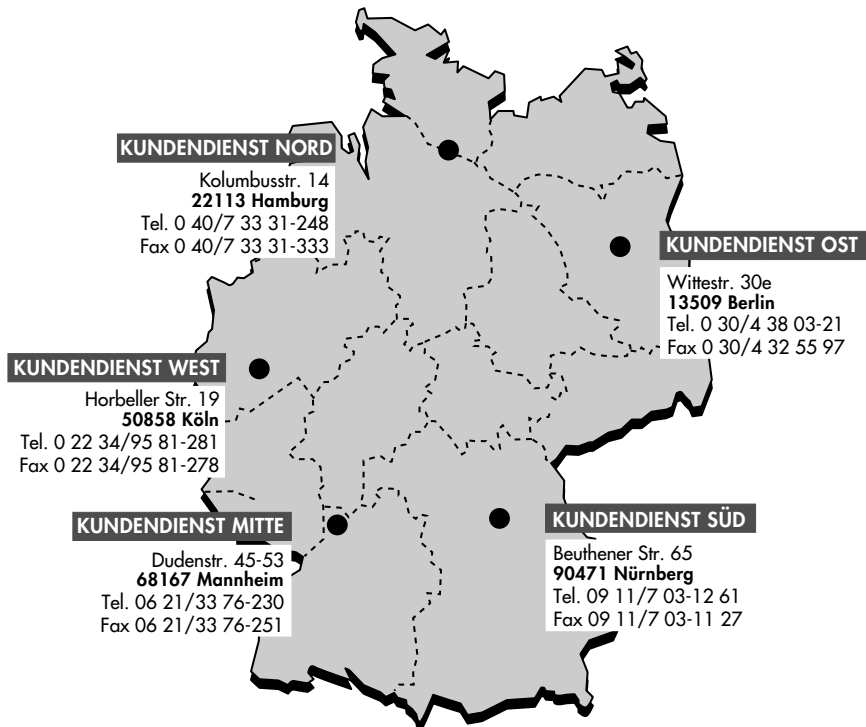

GRUNDIG

Kundendienst Europa

